



Operating Instructions
optoNCDT 1900
PROFINET

ILD1900-2
ILD1900-10
ILD1900-25
ILD1900-50
ILD1900-100

ILD1900-200
ILD1900-500

ILD1900-2LL
ILD1900-6LL
ILD1900-10LL
ILD1900-25LL
ILD1900-50LL

Intelligent laser-optical displacement measurement

MICRO-EPSILON
MESSTECHNIK
GmbH & Co. KG
Königbacher Str. 15

94496 Ortenburg / Deutschland

Tel. +49 (0) 8542 / 168-0
Fax +49 (0) 8542 / 168-90
e-mail info@micro-epsilon.com
www.micro-epsilon.com

optoNCDT 1900



Contents

1.	Safety	7
1.1	Symbols Used	7
1.2	Warnings	7
1.3	Notes on CE Marking	8
1.4	Intended Use	8
1.5	Proper Environment.....	9
2.	Laser Safety	10
2.1	General	10
2.2	Laser Class 2	10
2.3	Laser Class 3R.....	12
3.	Functional Principle, Technical Data	14
3.1	Short Description	14
3.2	Advanced Surface Compensation	15
3.3	Technical Data	16
3.3.1	ILD1900-xx.....	16
3.3.2	ILD1900-xxLL.....	18
4.	Delivery	20
4.1	Unpacking, Included in Delivery.....	20
4.2	Storage	20
5.	Assembly	21
5.1	Notes for Operation	21
5.1.1	Reflectance of Target Surface	21
5.1.2	Interferences.....	22
5.1.2.1	Ambient Light.....	22
5.1.2.2	Color Differences	22
5.1.2.3	Thermal Influences	22
5.1.2.4	Mechanical Vibrations	22
5.1.2.5	Motion Blur	22
5.1.2.6	Surface Roughness	23
5.1.2.7	Angular Influences	24
5.1.3	Optimizing the Measurement Accuracy.....	25

5.2	Mechanical Fastening, Dimensional Drawing	26
5.2.1	General	26
5.2.2	Mounting.....	26
5.3	Control and Indicator Elements	28
5.4	Electrical Connections.....	29
5.4.1	RJ45, PoE Connections	29
5.4.2	RJ45 Connection	30
5.4.3	Pin Assignment.....	31
5.4.4	Supply Voltage	32
5.4.5	Turning on the Laser.....	33
5.4.6	Plug-In Connection, Supply and Output Cable	34
6.	Operation	35
6.1	Getting Ready for Operation	35
6.2	Operation via Web Interface, Ethernet	36
6.2.1	General	36
6.2.2	Access via Web Interface	37
6.2.3	Measurement Task Selection	39
6.2.4	Display of Measurement Values in the Web Browser	40
6.2.5	Video Signal Display in the Web Browser.....	42
6.3	Parameter Setting via PROFINET	44
6.4	Timing, Measurement Value Cycles	44
6.5	Operation via Membrane Key.....	45
7.	Setting Sensor Parameters via Web Interface	46
7.1	Preliminary Remarks about the Setting Options.....	46
7.2	Parameters Overview	46
7.3	Inputs	47
7.4	Data Recording.....	48
7.4.1	Preliminary Remarks	48
7.4.2	Measurement Configuration.....	48
7.4.3	Measuring Rate	48
7.4.4	Reset Counter.....	48
7.4.5	ROI Masking	49
7.4.6	Exposure Mode	50
7.4.7	Peak Selection.....	51

7.5	Signal Processing	52
7.5.1	Preliminary Remarks	52
7.5.2	Averaging	52
	7.5.2.1 General	52
	7.5.2.2 Moving Average	53
	7.5.2.3 Recursive Average	54
	7.5.2.4 Median	54
7.5.3	Zeroing, Mastering	55
7.6	PROFINET Digital Values	56
7.6.1	Values, Ranges	56
7.6.2	Behavior of the Distance Values	58
7.7	System Settings	60
7.7.1	General	60
7.7.2	Unit, Language	60
7.7.3	Load & Save	61
7.7.4	Import, Export	63
7.7.5	Reset Sensor	64
7.7.6	Bootmode	64
8.	PROFINET Documentation	65
8.1	Preliminary Remarks	65
8.2	General, Initial Operation	65
8.3	Cyclic Data Traffic	66
8.4	Data Format, Little-Endian	70
8.5	Acyclic Reading and Writing of Records	71
8.5.1	General	71
8.5.2	I&M Records	71
8.5.3	Parameter Documentation	74
	8.5.3.1 General	74
	8.5.3.2 Licht Source	74
	8.5.3.3 Measurement Configuration, Measuring Rate, Evaluation Range (ROI), Exposure, Peak Selection, Error Handling	75
	8.5.3.4 Averaging	76
	8.5.3.5 Zeroing, Mastering	77
	8.5.3.6 System Settings, Key Lock, Login, Password, Factory Settings	78
	8.5.3.7 Load, Save Device Settings	79
	8.5.3.8 Load and Apply Presets	80
	8.5.3.9 Load, Save and Apply Setups	80
	8.5.3.10 Sensor Information	81

8.5.4	Acyclic Reading of the Cyclic Process Data (Index 0x6000)	82
8.5.5	Parameter Records (Index 0x2000 – 0x2FFF)	83
8.5.5.1	General	83
8.5.5.2	Record Parameter Info 0x2501	84
8.5.5.3	Record Float Parameter 0x2510, Examples	85
8.5.5.4	Record Signed-Integer Parameter 0x2520	88
8.5.5.5	Record Unsigned-Integer Parameter 0x2530, Example	89
8.5.5.6	Record String Parameter 0x2540	91
8.6	Installing the GSDML file	92
8.7	Configuring the Module	93
8.8	Acyclic Reading and Writing of Records via TIA-Portal	95
8.8.1	Sequence When Writing and Reading Acyclical Data	95
8.8.2	Sequence When Writing Structured Data	98
9.	Cleaning	99
10.	Disclaimer	99
11.	Service, Repair	100
12.	Decommissioning, Disposal	100
Appendix		
A 1	Optional Accessories	101
A 2	Factory Settings	102
A 3	Configuring the IP Adress	103
A 4	PROFINET Parameter List	113

1. Safety

System operation assumes knowledge of the operating instructions.

1.1 Symbols Used

The following symbols are used in these operating instructions:



Indicates a hazardous situation which, if not avoided, may result in minor or moderate injury.



Indicates a situation that may result in property damage if not avoided.



Indicates a user action.



Indicates a tip for users.

Measurement

Indicates hardware or a software button/menu.

1.2 Warnings



Connect the power supply according to the regulations for electrical equipment.

- > Risk of injury
- > Damage to or destruction of the sensor



Avoid shocks and impacts to the sensor.

Damage to or destruction of the sensor

Install the sensor on a flat surface using only the mounting holes/threaded holes provided, any type of clamping is not permitted.

- > Damage to or destruction of the sensor

The supply voltage must not exceed the specified limits.

- > Damage to or destruction of the sensor

Protect the sensor cable against damage. Attach the cable without load, secure the cable after approx. 25 cm and the pigtail on the connector, e.g. using cable ties.

- > Destruction of the sensor, failure of the measuring device

NOTICE

Avoid constant exposure of the sensor to splashes of water.

> Damage to or destruction of the sensor

Avoid exposure of sensor to aggressive media (detergents, cooling emulsions).

> Damage to or destruction of the sensor

1.3 Notes on CE Marking

The following apply to the optoNCDT 1900 measuring system:

- EU Directive 2014/30/EU
- EU Directive 2011/65/EU

Products which carry the CE mark satisfy the requirements of the EU directives cited and the relevant applicable harmonized European standards (EN). The measuring system is designed for use in industrial environments.

The EU Declaration of Conformity and the technical documentation are available to the responsible authorities according to the EU Directives.

1.4 Intended Use

- The optoNCDT 1900 is designed for use in industrial and laboratory applications. It is used for
 - Measuring displacement, distance, position and thickness
 - Monitoring quality and checking dimensions
- The sensor must only be operated within the values specified in the technical data see Chap. 3.3.
- The sensor must be used in such a way that no persons are endangered or machines are damaged in the event of malfunction or total failure of the sensor.
- Take additional precautions for safety and damage prevention in case of safety-related applications.

1.5 Proper Environment

- Protection class: IP67 (applies only when sensor cable is plugged in)

Lenses are excluded from the protection class. Contamination of the lenses causes impairment or failure of the function.

- Temperature range:
 - Operation: 0 ... 50 °C
 - Storage: -20 ... 70 °C
- Humidity: 5 - 95% (non-condensing)
- Ambient pressure: Atmospheric pressure

i The protection class is limited to water, no penetrating liquids or the like.

2. Laser Safety

2.1 General

The optoNCDT 1900 operates with a semiconductor laser with a wavelength of 658 nm (visible/red) or 670 nm (visible/red).

When operating the optoNCDT 1900 sensors, the relevant regulations according to IEC 60825, Part 1 of 05/2014 and the applicable accident prevention regulations must be followed.

i If both warning labels are covered over when the unit is installed, the user must ensure that supplementary labels are applied.

Operation of the laser is indicated visually by the LED on the sensor, see Chap. 5.3.

The housing of the optical sensors may only be opened by the manufacturer, see Chap. 10.

For repair and service purposes, the sensors must always be sent to the manufacturer.

2.2 Laser Class 2

The sensors fall within laser class 2. The laser is operated on a pulsed mode, the maximum optical power is ≤ 1 mW. The pulse frequency depends on the adjusted measuring rate (0.25 ... 10 kHz). The pulse duration of the peaks is regulated depending on the measuring rate and reflectivity of the target and can be 4 up to 3995 μ s.



Laser radiation. Close your eyes or immediately turn away if the laser beam hits the eye. Irritation or injury of the eyes possible.

i Observe the laser protection regulations.

Although the laser output is low, directly looking into the laser beam must be avoided. Close your eyes or immediately turn away if the laser beam hits the eye. Lasers of Class 2 are not subject to notification and a laser protection officer is not required.

The following warning labels are attached to the sensor cable:

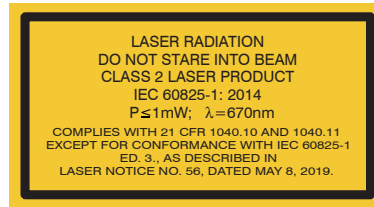

Fig. 1 Laser labels on the sensor cable

Fig. 2 Laser warning sign on the sensor housing

During operation of the sensor, the pertinent regulations according to IEC 60825-1 on „Safety of laser products“ must be fully observed at all times. The sensor complies with all applicable laws for the manufacturer of laser devices.

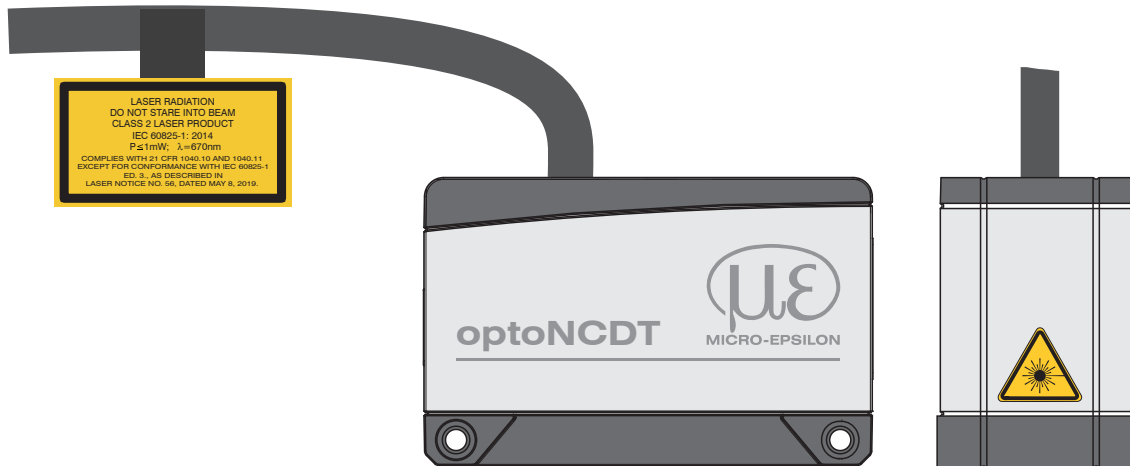

Fig. 3 Sensor cable and sensor with laser sign, class 2

2.3 Laser Class 3R

The sensors fall within laser class 3R. The laser is operated on a pulsed mode, the maximum optical power is ≤ 5 mW. The pulse frequency depends on the adjusted measuring rate (0.25 ... 10 kHz). The pulse duration of the peaks is regulated depending on the measuring rate and reflectivity of the target and can be 4 up to 3995 μ s.



Laser radiation. Use suitable protective equipment and close your eyes or immediately turn away if the laser beam hits the eye. Irritation or injury of the eyes possible.

- i Observe the laser protection regulations.

Accordingly, the following applies: The accessible laser radiation is harmful to the eyes. Looking directly into the laser beam is harmful to the eyes with laser class 3R devices. Reflections of shiny or mirroring surfaces are also harmful to the eyes.

Class 3R laser sensors require a laser protection officer.

Mark the laser area recognizable and everlasting. During operation the laser area has to be restricted and marked.

The following warning labels are attached to the sensor cable:



Fig. 4 Laser labels on the sensor cable

Fig. 5 Laser warning sign on the sensor housing

During operation of the sensor, the pertinent regulations according to IEC 60825-1 on „Safety of laser products“ must be fully observed at all times. The sensor complies with all applicable laws for the manufacturer of laser devices.

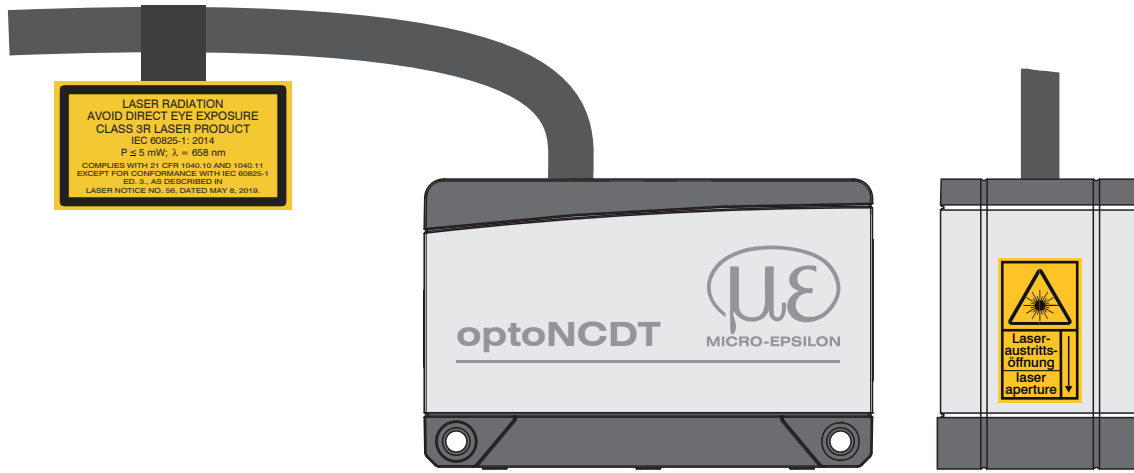

Fig. 6 Sensor cable and sensor with laser sign, class 3R

3. Functional Principle, Technical Data

3.1 Short Description

The optoNCDT 1900 operates according to the principle of optical triangulation, i.e. a visible, modulated light spot is projected onto the surface of the measuring object.

The diffuse part of the reflection of this light spot is imaged on a spatial resolution element (CMOS) by a receiver optic arranged at a certain angle to the optical axis of the laser beam.

A signal processor in the sensor calculates the distance between the light spot on the target and the sensor from the output signal of the CMOS element. The distance value is linearized and output via the PROFINET interface.

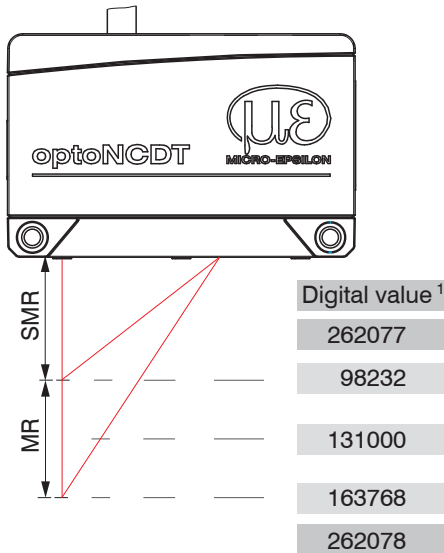

MR = Measuring range
 SMR = Start of measuring range
 MMR = Mid of measuring range
 EMR = End of measuring range

Fig. 7 Term definitions

1) For displacement values without zero setting or mastering.

3.2 Advanced Surface Compensation

The optoNCDT 1900 is equipped with an intelligent surface control feature. New algorithms generate stable measurement results even on demanding surfaces where changing reflections occur. Furthermore, these new algorithms compensate for ambient light up to 50,000 lux. Therefore, this is the sensor with the highest resistance to ambient light in its class which can even be used in strongly illuminated environments.

3.3 Technical Data

3.3.1 ILD1900-xx

Model	ILD1900-	2	6	10	25	50	100	200	500
Measuring range	mm	2	6	10	25	50	100	200	500
Start measuring range	mm	15	17	20	25	40	50	60	100
Mid measuring range	mm	16	20	25	37.5	65	100	160	350
End measuring range	mm	17	23	30	50	90	150	260	600
Measuring rate ¹		continuously adjustable between 0.25 ... 10 kHz 7 adjustable stages: 10 kHz / 8 kHz / 4 kHz / 2 kHz / 1.0 kHz / 500 Hz / 250 Hz							
Linearity	μm	$\leq \pm 1$	$\leq \pm 1.8$	$\leq \pm 2$	$\leq \pm 5$	$\leq \pm 10$	$\leq \pm 30$	$\leq \pm 100$	$\leq \pm 400$
	% FSO	$\leq \pm 0.05$	$\leq \pm 0.03$	$\leq \pm 0.02$			$\leq \pm 0.03$	$\leq \pm 0.05$	$\leq \pm 0.08$
Repeatability ²	μm	< 0.1	< 0.25	< 0.4	< 0.8	< 1.6	< 4	< 8	< 20 ... 40
Temperature stability ³		± 0.005 % FSO / K							
Light spot diameter (± 10 %) ⁴	SMR in μm	60 x 75	85 x 105	115 x 150	200 x 265	220 x 300	310 x 460	950 x 1200	950 x 1200
	MMR in μm	55 x 65	57 x 60	60 x 65	70 x 75	95 x 110	140 x 170		
	EMR in μm	65 x 75	105 x 120	120 x 140	220 x 260	260 x 300	380 x 410		
	smallest diameter	55 x 65 μm with 16 mm	57 x 60 μm with 20 mm	60 x 65 μm with 25 mm	65 x 70 μm with 35 mm	85 x 90 μm with 55 mm	120 x 125 with 75 mm	-	-
Light source		Semiconductor laser < 1 mW, 670 nm (red) with laser class 2 Semiconductor laser ≤ 5 mW, 658 nm (red) with laser class 3R							
Laser class		Class 2 according to IEC 60825-1: 2014 optionally class 3R according to IEC 60825-1: 2014							
Permissible ambient light		50,000 lx					30,000 lx	10,000 lx	
Supply voltage		11 ... 30 V DC or PoE, external supply has priority over PoE							
Power consumption		< 3 W (24 V)							

Model	ILD1900-	2	6	10	25	50	100	200	500
Signal input		Laser on/off							
Digital interface		PROFINET							
Connection		integrated pigtail 0.3 m with 12-pin M12 plug; optional extension to 3 m / 6 m / 9 m (see accessories for suitable connection cable)							
Temperature range	Storage	-20 ... +70°C (non-condensing)							
	Operation	0 ... +50°C (non-condensing)							
Shock (DIN EN 60068-2-27)		15 g / 6 ms							
Vibration (DIN EN 60068-2-6)		30 g / 20 ... 500 Hz							
Protection class (DIN EN 60529)		IP67							
Material		Aluminum housing							
Weight		approx. 185 g (incl. pigtail)							
Control and indicator elements		Select button: factory setting, Web interface for setup ⁵ : Application-specific presets; peak selection, video signal; freely selectable averaging possibilities; data reduction; setup management; 1 x color LED for power / status 2 x color LED for fieldbus status							

FSO = Full Scale Output, SMR = Start of measuring range, MMR = Mid of measuring range, EMR = End of measuring range

The specified data apply to a white, diffuse reflecting surface (Micro-Epsilon reference ceramic for ILD sensors)

- 1) Maximum measuring rate depending on fieldbus and bus cycle time; factory setting: measuring rate 4 kHz, median 9;
- 2) Typical value with measurements at 4 kHz and median 9
- 3) In the mid of the measuring range; the specified value is only achieved by mounting on a metallic sensor holder. Good heat dissipation from the sensor to the holder must be ensured.
- 4) Light spot diameter determined using a point-shaped laser with Gaussian fit (full $1/e^2$ width); for ILD1900-2: determined with emulated 90/10 knife-edge method
- 5) Connection to PC via network cable

3.3.2 ILD1900-xxLL

Model	ILD1900-	2LL	6LL	10LL	25LL	50LL
Measuring range		2 mm	6 mm	10 mm	25 mm	50 mm
Start of measuring range		15 mm	17 mm	20 mm	25 mm	40 mm
Mid of measuring range		16 mm	20 mm	25 mm	37.5 mm	65 mm
End of measuring range		17 mm	23 mm	30 mm	50 mm	90 mm
Measuring rate ¹		continuously adjustable between 0.25 ... 10 kHz; 7 adjustable stages: 10 kHz / 8 kHz / 4 kHz / 2 kHz / 1.0 kHz / 500 Hz / 250 Hz				
Linearity		< ±1 μm	< ±1.2 μm	< ±2 μm	< ±5 μm	< ±10 μm
		< ± 0.05 % FSO	< ± 0.02 % FSO	< ± 0.02 % FSO	< ± 0.02 % FSO	< ± 0.02 % FSO
Repeatability ²		< 0.1 μm	< 0.25 μm	< 0.4 μm	< 0.8 μm	< 1.6 μm
Temperature stability ³		±0.005 % FSO / K				
Light spot diameter (± 10 %) ⁴	SMR	55 x 480 μm	100 x 600 μm	125 x 730 μm	210 x 950 μm	235 x 1280 μm
	MMR	40 x 460 μm	50 x 565 μm	55 x 690 μm	80 x 970 μm	125 x 1500 μm
	EMR	55 x 440 μm	100 x 525 μm	125 x 660 μm	220 x 1000 μm	325 x 1470 μm
	smallest diameter	40 x 460 μm with 16 mm	50 x 565 μm with 20 mm	55 x 690 μm with 25 mm	80 x 970 μm with 37.5 mm	115 x 1450 μm with 59 mm
Light source		Semiconductor laser < 1 mW, 670 nm (red) with laser class 2 Semiconductor laser ≤ 5 mW, 658 nm (red) with laser class 3R				
Laser class		Class 2 according to IEC 60825-1: 2014 optionally class 3R according to IEC 60825-1: 2014				
Permissible ambient light		50,000 lx				
Supply voltage		11 ... 30 VDC or PoE, external supply has priority over PoE				
Power consumption		< 3 W (24 V)				

Model	ILD1900-	2LL	6LL	10LL	25LL	50LL
Signal input		Laser on/off				
Digital interface		PROFINET				
Connection		integrated pigtail 0.3 m with 12-pin M12 plug; optional extension to 3 m / 6 m / 9 m (see accessories for suitable connection cable)				
Temperature range	Storage	-20 ... +70 °C, non-condensing				
	Operation	0 ... +50 °C, non-condensing				
Shock (DIN EN 60068-2-27)		15 g / 6 ms in 3 axes				
Vibration (DIN EN 60068-2-6)		30 g / 20 ... 500 Hz				
Protection class (DIN EN 60529)		IP67				
Material		Aluminum housing				
Weight		approx. 185 g (incl. pigtail)				
Control and display elements		Select button: factory setting, Web interface for setup ⁵ : Application-specific presets; peak selection, video signal; freely selectable averaging possibilities; data reduction; setup management; 1 x color LED for power / status 2 x color LED for fieldbus status				

FSO = Full Scale Output, SMR = Start of measuring range, MMR = Mid of measuring range, EMR = End of measuring range

The specified data apply to white, diffuse reflecting surfaces (Micro-Epsilon reference ceramic for ILD sensors)

- 1) Maximum measuring rate depending on fieldbus and bus cycle time; factory setting: measuring rate 4 kHz, median 9;
- 2) Typical value with measurements at 4 kHz and median 9
- 3) In the mid of the measuring range; the specified value is only achieved by mounting on a metallic sensor holder. Good heat dissipation from the sensor to the holder must be ensured.
- 4) Light spot diameter with line-shaped laser determined based on the emulated 90/10 knife-edge method
- 5) Connection to PC via network cable

4. Delivery

4.1 Unpacking, Included in Delivery

- 1x ILD1900-x-PROFINET sensor
- 1 Assembly Instructions
- 1 Calibration protocol
- Accessories (2 pc. centering sleeves, 2 pc. M3 x 40)

optoNCDT 1900 DC 11-30V ⁻⁻⁻⁻
ILD1900-xx-IE max. 500 mA
00xxxxxxxxx COO: Germany
MAC: 00-0C-12-01-C7-4F



Fig. 8 Label on sensor

- ▶ Carefully remove the components of the measuring system from the packaging and ensure that the goods are forwarded in such a way that no damage can occur.
- ▶ Check the delivery for completeness and shipping damage immediately after unpacking.
- ▶ If there is damage or parts are missing, immediately contact the manufacturer or supplier.

Optional accessories are listed in the appendix see Chap. A 1.

4.2 Storage

Temperature range for storage: -20 ... +70 °C
Humidity: 5 - 95% (non-condensing)

5. Assembly

5.1 Notes for Operation

5.1.1 Reflectance of Target Surface

In principle, the sensor evaluates the diffuse portion of the reflections of the laser light spot.

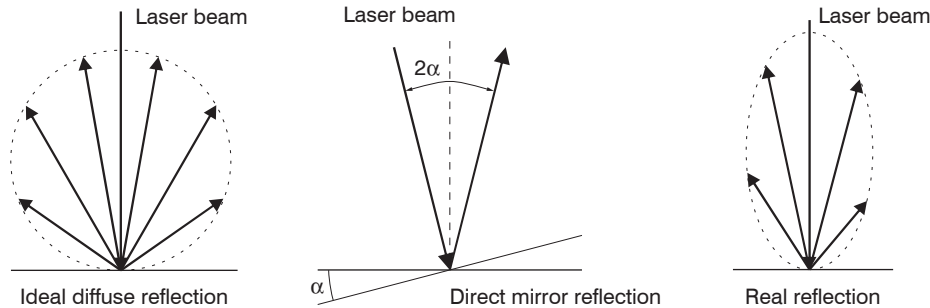

Fig. 9 Reflectance of target surface

Any statement about a minimum reflection factor is only possible with reservations, since small diffuse portions can be evaluated even of reflecting surfaces. This happens based on intensity determination of the diffuse reflection from the CMOS signal in real time and subsequent control, see Chap. 3.2. However, for dark or shiny measuring objects, such as black rubber, a longer exposure time may be required. The maximum exposure time is coupled to the measuring rate and can only be increased by lowering the measuring rate of the sensor.

5.1.2 Interferences

5.1.2.1 Ambient Light

Thanks to their integrated optical interference filters, the optoNCDT 1900 laser-optical sensors offer outstanding performance in suppressing ambient light. However, ambient light disturbances can occur with shiny measuring objects and at a reduced measuring rate. In these cases it is recommended to provide shielding against ambient light or to switch on the `Background suppression` function. This applies in particular to measurement work performed in the vicinity of welding devices.

5.1.2.2 Color Differences

Because of intensity compensation, color difference of targets affect the measuring result only slightly. However, such color differences are often combined with different penetration depths of the laser light into the material. Different penetration depths then result in apparent changes of the measuring spot size. Therefore color changes in combination with penetration depth changes may lead to measurement uncertainties.

5.1.2.3 Thermal Influences

When the sensor is commissioned, a warm-up time of at least 20 minutes is required to achieve uniform heat distribution in the sensor. If measurement is performed in the μm accuracy range, the effect of temperature fluctuations on the sensor holder must be considered.

Rapid temperature changes are not detected immediately due to the damping effect of the sensor's heat capacity.

5.1.2.4 Mechanical Vibrations

If a high degree of resolution in the μm range is required, the sensor and target must be mounted on a stable surface that is damped against vibrations.

5.1.2.5 Motion Blur

Fast moving targets and a low measuring rate may also cause motion blurring. Therefore, always select a high measuring rate for high-speed operations to prevent errors.

5.1.2.6 Surface Roughness

Laser-optical sensors detect the surface using an extremely small laser spot. They also track slight surface unevenness. In contrast, a tactile, mechanical measurement, e.g. using a caliper, detects a much larger area of the measuring object. In case of traversing measurements, surface roughnesses of $5 \mu\text{m}$ and more lead to an apparent distance change.

A suitable averaging number may improve the comparability of optical and mechanical measurements.

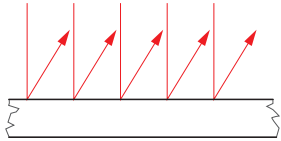

Ceramic reference surface

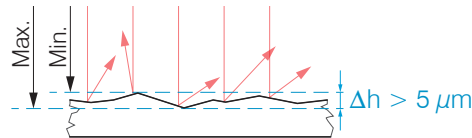

Structured surface

Recommendation for parameter choice:

- The averaging number should be selected in such a way that a surface area the size of which is comparable to those with mechanical measurements is averaged.

5.1.2.7 Angular Influences

Target tilt angles around both the X and Y-axis of less than 5° in the case of diffuse reflection only cause problems with surfaces that produce strong direct reflection.

These influences must be taken into account especially when scanning profiled surfaces. In principle, angular behavior of triangulation is also subject to the reflective properties of the target surface.

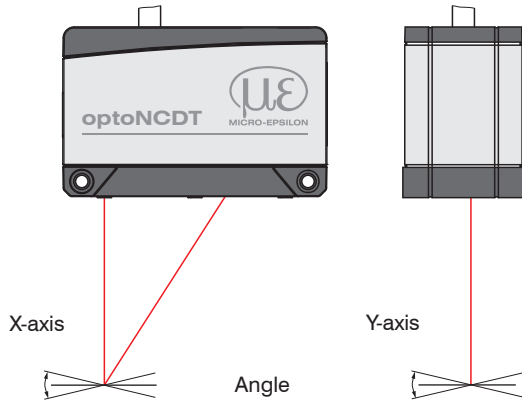
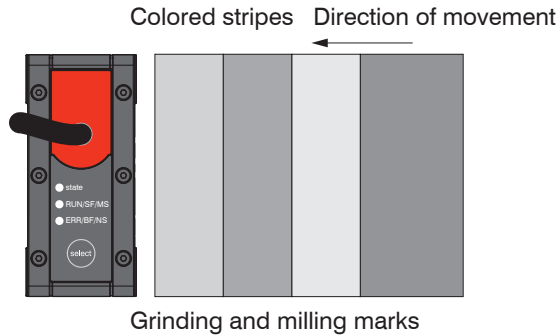

Fig. 10 Measurement error caused by tilt angle with diffuse reflection

5.1.3 Optimizing the Measurement Accuracy



In case of rolled or polished metals that are moved past the sensor, the sensor plane must be arranged in the direction of the rolling or grinding marks. The same arrangement must be used for color stripes.

Fig. 11 Sensor arrangement for ground or striped surfaces

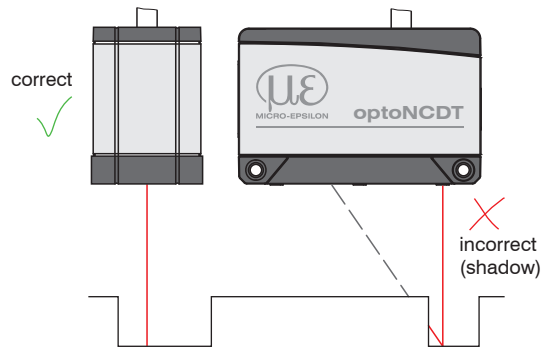

In case of bore holes, blind holes and edges in the surface of moving parts, the sensor must be arranged in such a way that the edge does not obscure the laser spot.

Fig. 12 Sensor arrangement for holes and edges

5.2 Mechanical Fastening, Dimensional Drawing

5.2.1 General

The optoNCDT 1900 sensor is an optical system used to measure in the micrometer range. If the laser beam does not strike the object surface at a perpendicular angle, measurements might be inaccurate.

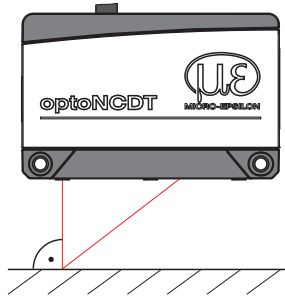

i Ensure careful handling of the sensor during installation and operation. Mount the sensor only to the existing through-bores on a flat surface. Any type of clamping is not permitted. Do not exceed torques.

The bearing surfaces surrounding the through-holes (fastening holes) are slightly raised.

Fig. 13 Sensor mounting with diffuse reflection

5.2.2 Mounting

Depending on the installation position, it is recommended to define the sensor position using centering elements and fitting bores. The cylindrical counterbore $\varnothing 6$ H7 is intended for the position-defining centering elements. This allows for the sensor to be mounted in a reproducible and exchangeable way.

Bolt connection

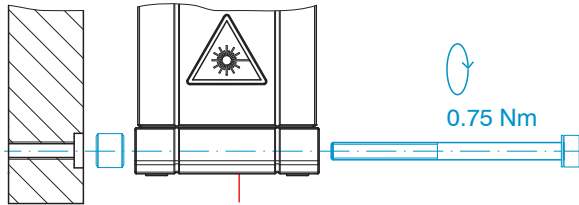

M3 x 40; ISO 4762, A2-70

Direct fastening

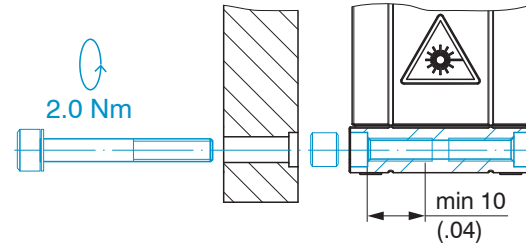

M4; ISO 4762, A2-70
Screwing depth min. 10 mm

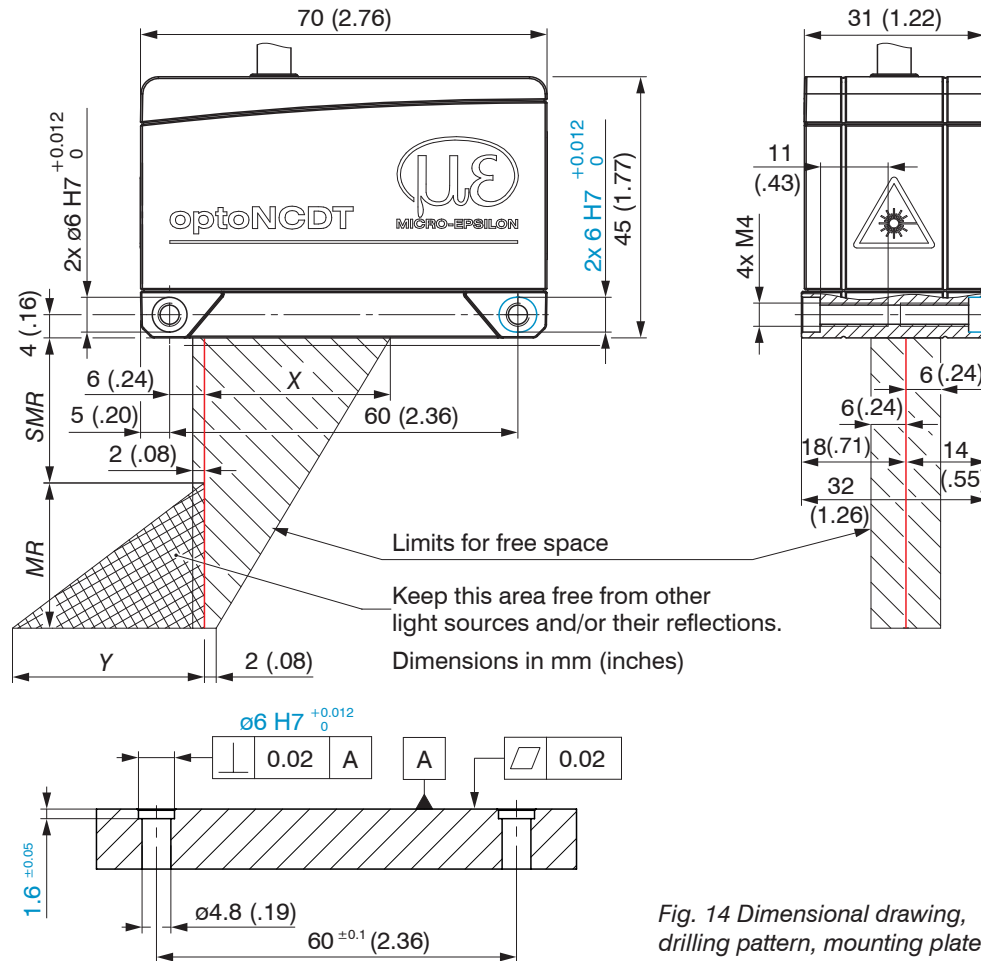

Fig. 14 Dimensional drawing, drilling pattern, mounting plate

i Mount the sensor only to the existing through-bores on a flat surface or screw it directly. Any type of clamping is not permitted.

MR	SMR	X	Y
2/2LL	15	23	3
6/6LL	17	27	9
10/10LL	20	33	14
25/25LL	25	33	33
50/50LL	40	36	45
100	50	37	75
200	60	39	130
500	100	43	215

Dimensions in mm

MR = Measuring range

SMR = Start of measuring range

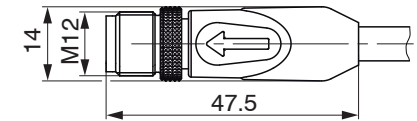







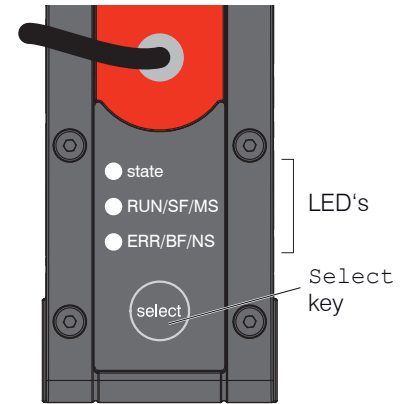







Fig. 15 Dimensional drawing of plug and sensor cable

5.3 Control and Indicator Elements

LED State / Color / State		Meaning
 green	On	Measuring object within the measuring range
 yellow	On	Measuring object in the mid of the measuring range
 red	On	No distance value available, e.g. target outside the measuring range, too low reflection
 yellow	Flashing, 1 Hz	Bootloader
 yellow	Flashing, 8 Hz	Installation active
	Yellow (briefly), red, yellow, green, off, alternating	Ethernet setup mode
	Off	Laser switched off
Select button		Reset to factory setting



LED / Color / State		Meaning	
SF (System failure) General name: COM 0	Duo-LED red/green		
		Off	No error
	 red	Flashing (1 Hz, 3 s)	DCP signal service is initiated via the bus
	 red	On	Watchdog timeout; channel, generic or extended diagnosis present; system error
BF (Bus failure) General name: COM 1	Duo-LED red/green		
		Off	No error
	 red	Flashing (2 Hz)	No data exchange
	 red	On	No configuration; or low speed physical link; or no physical link

5.4 Electrical Connections

5.4.1 RJ45, PoE Connections

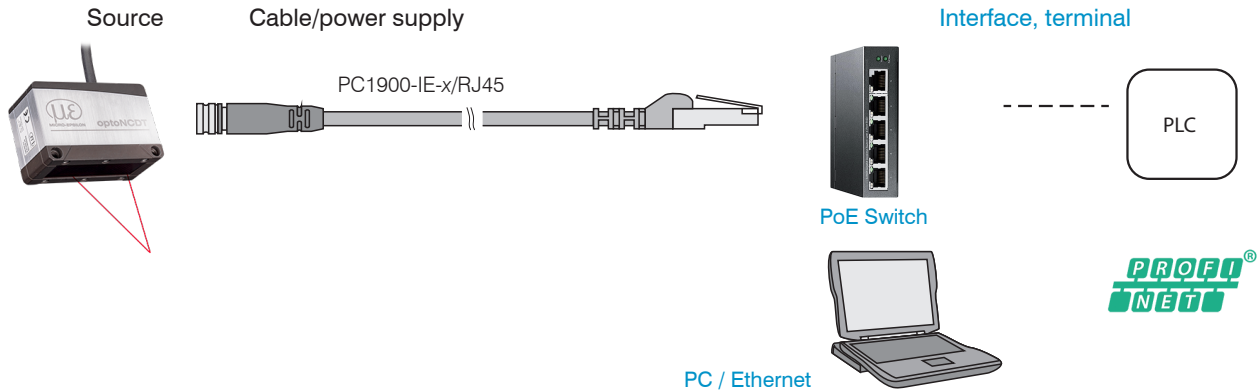

Fig. 16 IL1900-x-PROFINET connection example, laser on/off via software

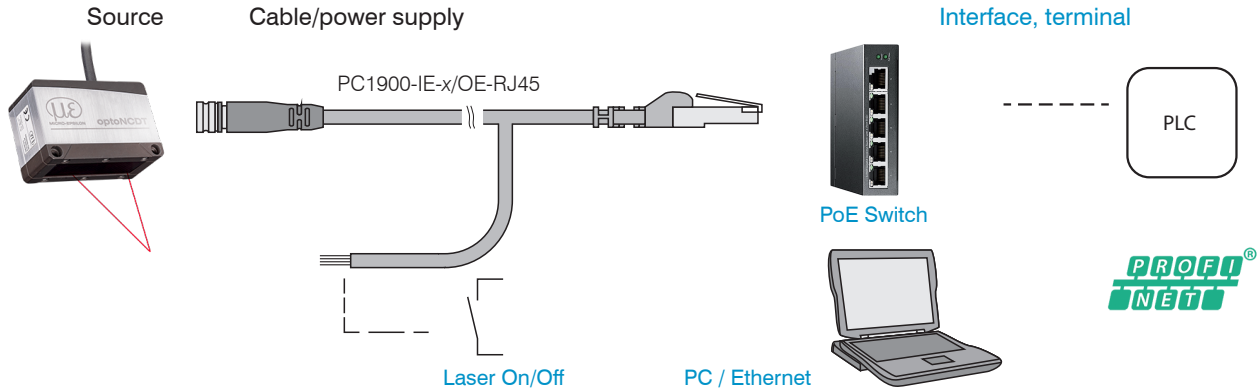

Fig. 17 IL1900-x-PROFINET connection example, laser on/off via hardware
optoNCDDT 1900 / PROFINET

5.4.2 RJ45 Connection

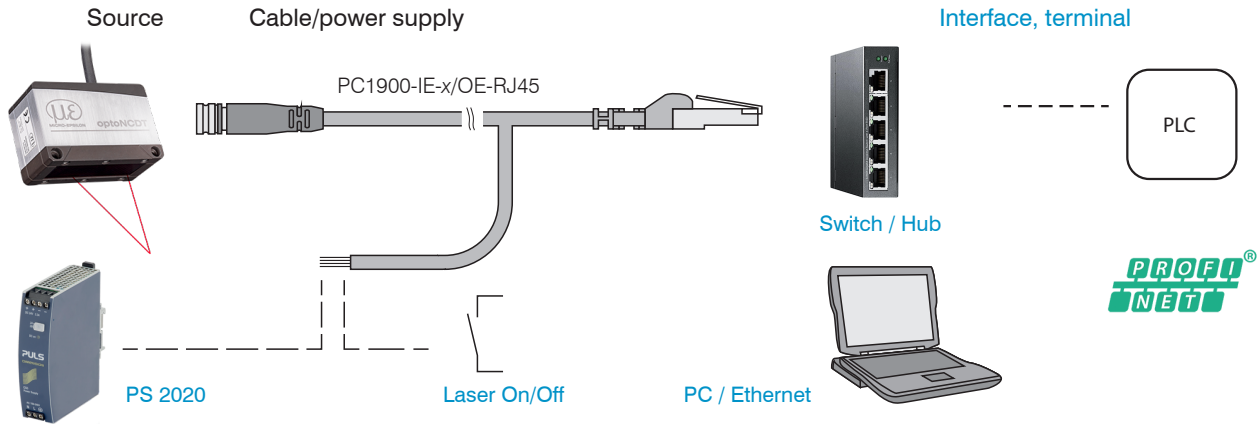

Fig. 18 ILD1900-x-PROFINET connection example, supply via optional power supply unit, laser on/off via hardware

5.4.3 Pin Assignment

Signal	Wire color PC1900-IE-x/OE-RJ45	Comments	
V_+	Red	Power supply	11 ... 30 VDC, typ. 24 VDC
GND	Blue	Reference ground	
Laser on/off +	Black	Switching input	Laser in the sensor is active if both pins are connected to each other.
Laser on/off -	Violet		

Fig. 19 Open end connections, PC1900-IE-x/OE-RJ45

Signal	Pin	Comments	
V_+	1	Power supply	11 ... 30 VDC, typ. 24 VDC
GND	2	Reference ground	
Laser on/off +	7	Switching inputs, see Chap. 5.4.5	
Laser on/off -	8		

Fig. 20 Pigtail connection on the sensor

5.4.4 Supply Voltage

Nominal value: 24 V DC (11 ... 30 V, P < 3 W).

PROFINET with PoE	PROFINET without PoE												
<p>Sensor supply is via a PoE-capable switch. Phantom powering (PoE) is possible via the</p> <ul style="list-style-type: none"> - PC1900-IE-x/RJ45 or - PC1900-IE-x/OE-RJ45 cables. 	Sensor supply is via the PC1900-IE-x/OE-RJ45 cable.												
		<table border="1"> <thead> <tr> <th>Sensor Pin</th> <th>PC1900-IE-x/OE-RJ45 Color</th> <th>Power supply</th> </tr> </thead> <tbody> <tr> <td>1</td> <td>Red</td> <td>V₊</td> </tr> <tr> <td>2</td> <td>Blue</td> <td>GND</td> </tr> </tbody> </table>	Sensor Pin	PC1900-IE-x/OE-RJ45 Color	Power supply	1	Red	V ₊	2	Blue	GND		
	Sensor Pin	PC1900-IE-x/OE-RJ45 Color	Power supply										
1	Red	V ₊											
2	Blue	GND											
<p>As an alternative to PoE, the sensor can be supplied with the optional PS2020 power supply unit see Fig. 18.</p> <p>Voltage supply only for measuring devices, not to be used for drives or similar sources of impulse interference at the same time. MICRO-EPSILON recommends using an optional available power supply unit PS2020 for the sensor.</p> <ul style="list-style-type: none"> ➡ Only turn on the power supply after wiring has been completed. ➡ Connect the inputs Pin 1 and Pin 2 at the sensor with a 24V power supply. 													

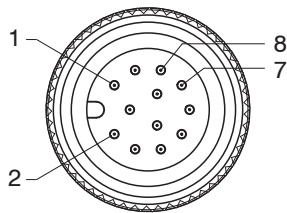
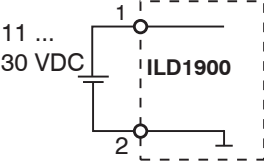
5.4.5 Turning on the Laser

The measuring laser on the sensor is switched on via a software command or a switching input. This allows to switch off the sensor for maintenance purposes or similar. Response time: after the laser is switched on, the sensor needs depending on the measuring rate 5 cycles to send correct measured data.

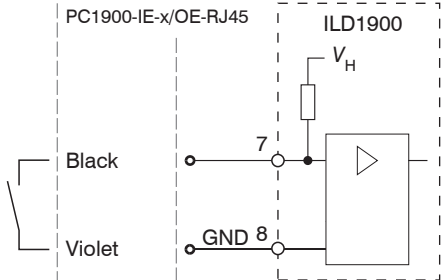
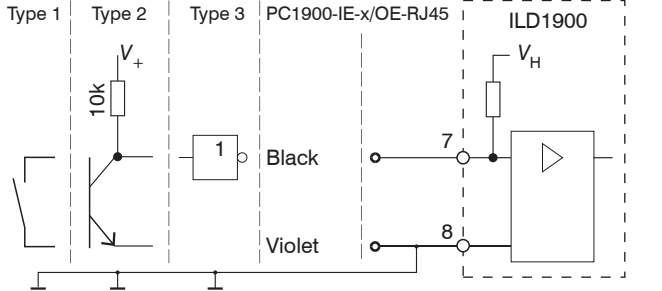
<p>Laser on/off via software, Supply with PoE</p> <p>The measuring laser on the sensor is activated via a software command.</p>	<p>Laser on/off via hardware, Supply with PoE</p> <p>The measuring laser on the sensor is activated via a switch or similar.</p>	<p>Laser on/off via hardware, Supply without PoE</p> <p>A switching transistor with open collector (for example in an optocoupler), a relay contact or a digital TTL or HTL signal are suitable for switching.</p>
<p>Activation using the PC1900-IE-x/RJ45 cable is possible.</p>	<p>Activation using the PC1900-IE-x/OE-RJ45 possible.</p> 	<p>Activation using the PC1900-IE-x/OE-RJ45 possible.</p>  <p>The inputs are not electrically separated. 24 V logic (HTL): Low level ≤ 3 V; High level ≥ 8 V (max 30 V) internal pull-up resistor, an open input is detected as High. Max. switching frequency 10 Hz. The ground of the logic circuit must be galvanically connected to "Laser on/off -".</p> <p>No external resistance is required for current limitation. For permanent "Laser on", connect the black and violet wires.</p>

5.4.6 Plug-In Connection, Supply and Output Cable

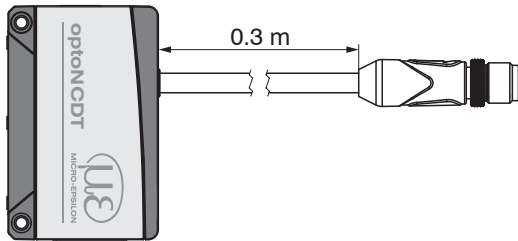

ILD1900-x-PROFINET with pigtail

- ▶ Do not bend the sensor cable more tightly than 30 mm (fixed installation) or 75 mm (permanently flexible).
- i The firmly connected sensor cable is drag-chain suitable.
- i Unused open cable ends must be insulated to protect against short circuits or sensor malfunctions.

MICRO-EPSILON recommends the use of the PC1900-IE drag-chain compatible standard connection cables from the optional accessories see Chap. [A 1](#).

- ▶ Fasten the plug connection of the cable plug and socket when using a drag-chain compatible PC1900-IE sensor cable.
- ▶ Avoid excessive pull on the cables. If a cable of over 5 m in length is used and it hangs vertically without being secured, make sure that some form of strain relief is provided close to the plug connection.
- ▶ Do not twist a mated connection.
- ▶ Connect the cable shield to the potential equalization (PE, protective earth conductor) on the evaluator (control cabinet, PC housing) and avoid ground loops.
- ▶ Never lay signal lines next to or together with power cables or pulse-loaded cables (e.g., for drives or solenoid valves) in a single bundle or duct. Always use separate ducts.

6. Operation

6.1 Getting Ready for Operation

- ▶ Mount the optoNCDT 1900 according to the assembly instructions, see Chap. 5.
- ▶ Connect the sensor to the downstream display or monitoring units and to the voltage supply, if no PoE is used.

The laser diode in the sensor is only activated

- due to software command or
- if the black and violet wires of the PC1900-IE-x/OE-RJ45 are connected, see Chap. 5.4.5.

Once the power supply has been switched on, the sensor runs through an initialization sequence. Already within the first second a connection to the sensor can be established and the measurement can be started.

During the first three seconds, an internal function check in the sensor is indicated by the Status LED, which lights up in the colors red, yellow and green one after another.

Initialization takes a maximum of 3 seconds. Within this period, only the reset or the bootloader command is executed via the `Select` button.

The sensor typically requires a warm-up time of 20 min for reproducible measurements.

If the `State` LED is off, the laser light source has been switched off.

If all LEDs are off, no power is being supplied, see Chap. 5.3.

6.2 Operation via Web Interface, Ethernet

6.2.1 General

The sensors start with the last stored operating mode. Standard is PROFINET.

i The ILD1900-x with PROFINET has no IP address by default. The IP address and the device name are assigned via the PROFINET Discovery Protocol. The IP address and the device name can be assigned, e.g., via the TIA Portal software.

A web server is implemented in the sensor; the web interface displays, among other things, the current settings of the sensor. Operation is only possible while there is an Ethernet connection to the sensor.

PROFINET Operation

➡ Assign an IP address to the sensor.

You can find an example of this in the appendix, see Chap. [A 3](#).

➡ Start your web browser and type the IP address of the sensor into the address bar.

Firmware update is possible with PROFINET operation.

6.2.2 Access via Web Interface

▶ Start the sensor web interface, see Chap. 6.2.1.

Interactive web pages you can use to configure the sensor are now displayed in the web browser. The sensor is active and supplies measurement values. Real-time measuring is not guaranteed with the web interface. The currently running measurement can be controlled using the function buttons in the `chart` type.



The horizontal navigation includes the functions below:

- The search function permits time-saving access to functions and parameters.
- Home. The web interface automatically starts the measurement view, Signal quality and Configurations.
- Measurement configuration. Allows a selection of predefined measurement settings.
- Settings. Configuration of the sensor parameters see Chap. 7.
- Measurement chart. Measurement chart or video signal display.
- Info. Includes information about the sensor, such as measuring range, serial number and software status.

Fig. 21 First page after web interface has been accessed in Ethernet mode

For configuration, you can switch between the video signal and the display for the measured values. The appearance of the websites depends on the functions. Dynamic help text with excerpts from the operating instructions supports you during sensor configuration.

i Depending on the selected measuring rate and the PC used, measured values may be reduced in the display. This means that not all measured values are transmitted to the web interface for display and saving.

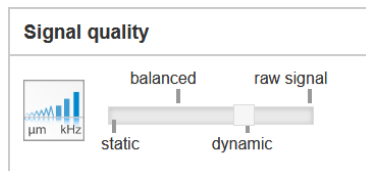



Averaging	Description
Balanced Median with 9 values + Moving with 64 values	<p>The <code>Signal quality</code> section enables to switch between four preset basic settings (Static, Balanced, Dynamic and without averaging). The effects are immediately displayed in the chart and the system configuration.</p> <p>i If the sensor is started with a user-specific measurement setting (Setup), see Chap. 7.7.3, changing the signal quality is not possible.</p> <p>The Signal Quality function can be used to specify the predefined presets more precisely for the individual measurement task.</p>
Raw signal, without averaging	
Static Median with 9 values + Moving with 128 values	
Dynamic Median, 9 values	

System configuration

Measuring rate
 4.000 kHz

Averaging 1
 Median: 9

Averaging 2
 Inactive

RS422
 921.6 kbps: Distance 1

The `System configuration` section shows the current settings for Measuring rate, Averaging and RS422 in blue. You can change the settings via the `Signal Quality` slider or in the `Settings` tab.



The Chart Type area allows switching between the graphical representation of the measured values over time or the video signal.

i After parameterization, store all settings permanently in a parameter set so that they are available again the next time the sensor is switched on.

To do this, use the `Save settings` button.

6.2.3 Measurement Task Selection

Conventional measurement configurations (presets) for various target surfaces are saved in the sensor. This allows you to quickly start with your individual measurement task. Selecting a preset, which is suitable for the target surface activates a predefined configuration of settings that will produce the best results for the material selected.

Measuring task		
Selecting target characteristics		
 Standard	Standard	Ceramics, metal
 Changing surfaces	Changing surfaces ¹	PCBs, hybrid metal
 Material with penetration	Material with penetration ¹	Plastics (Teflon, POM), materials with strong penetration depth of the laser

1) Available for sensor models with 2, 6, 10, 25 or 50 mm measuring range

6.2.4 Display of Measurement Values in the Web Browser

► Display the measurement values in the Measurement chart tab.

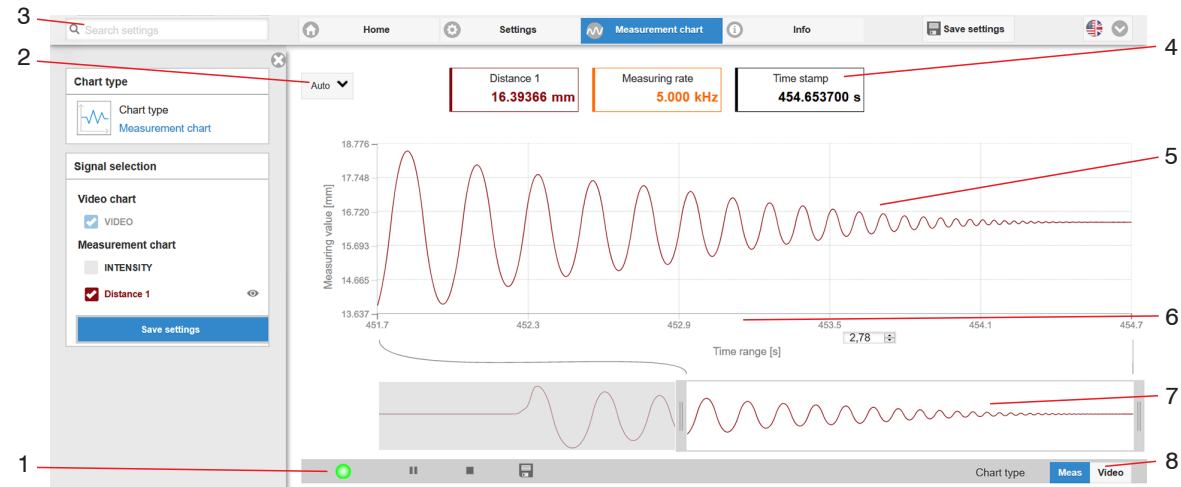

Fig. 22 Measurement (distance measurement) web page

- 1 The LED visualizes the status of the transmission of measured values:
 - green: transmission of measured values is running.
 - gray: transmission of measured values stopped

Data queries are controlled by using the Play/Pause/Stop/Save buttons of the measured values that were transmitted. Stop pauses the chart; you can still use the data selection and zoom functions. Pause stops the recording. Save opens the Windows selection dialog for the file name and storage location to save the last 10,000 values in a CSV file (separation using semicolon).

► Click the ► button (Start) to display the measurement results.

- 2 To scale the axis in the graph for the measured values (y-axis), you can use `Auto` (= automatic scaling) or `Manual` (= manual scaling).
- 3 The search function permits time-saving access to functions and parameters.
- 4 The text boxes above the graphic display the current values for distance, exposure time, current measuring rate, display rate and time stamp.
- 5 Mouseover function. When the chart has been stopped and you move the mouse over the graph, points on the curve are marked with a circle and the associated values are displayed in the text boxes above the graph. Peak intensity is also updated.
- 6 The x-axis can be scaled in the input field under the time axis.
- 7 Scaling the x-axis: During an ongoing measurement, you can use the left-hand slider to enlarge the entire signal (zoom). When the chart has been stopped, the right-hand slider can also be used. You can also move the zoom window with the mouse in the center of the zoom window (four-sided arrow).
- 8 Select a chart type: measurement values or video signal

6.2.5 Video Signal Display in the Web Browser

➡ Display the video signal in the Video section of the Chart type selection.

The graph displayed in the large chart area on the right represents the video signal and the receiving row. The video signal displayed in the chart area displays the intensity distribution of the pixels in the receiving row. Left 0 % (short distance), and right 100 % (large distance). The corresponding measurement value is marked by a vertical line (peak marking).

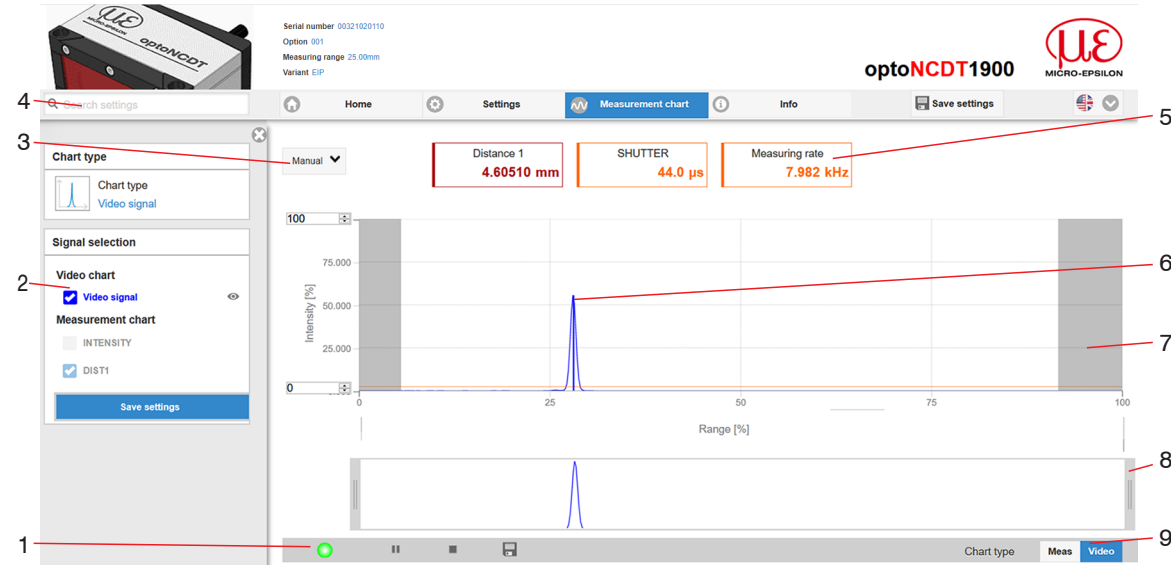

Fig. 23 Video signal web page

1 The LED visualizes the status of the transmission of measured values:

- green: transmission of measured values is running.
- gray: transmission of measured values stopped

Data queries are controlled by using the buttons *Play/Pause/Stop/Save* the measured values that were transmitted

Stop pauses the chart; you can still use the data selection and zoom functions. *Save* opens a Windows selection dialog for the file name and storage location to save the video signal in a CSV file.

 Click on the  button (Start) to display the video signal.

2 In the left-hand window, the video channels to be displayed can be switched on or off during or after the measurement. Inactive curves are grayed out and can be added by clicking on the check mark. If you want to have displayed one single signal, click on its name.

- Peak marking (vertical blue line), corresponds to the evaluated measured value
- Linearized measuring range (limited by gray hatching), not changeable
- Masked range (limited by light blue hatching), changeable

3 To scale the intensity axis in the graph for the measured values (y-axis), you can use *Auto* (= automatic scaling) or *Manual* (= manual scaling).

4 The search function permits time-saving access to functions and parameters.

5 The text boxes display the current values for distance, exposure time, current measuring rate, display rate and time stamp.

6 Mouseover function. When the chart has been stopped and you move the mouse over the graph, points on the curve are marked with a circle and the associated intensity is displayed. The corresponding x position is displayed in % above the graph window.

7 The linearized range is in the graph between the gray shadows and can not be changed. Only peaks of which the centers are in this range can be evaluated. The masked range may be limited if needed. Then an additional pale blue shadow limits the range on the right and on the left side. The peaks remaining in the resulting range are used for evaluation, see Chap. [7.4.5](#).

- 8 Scaling the x-axis: You can zoom into the graph shown above with the two sliders on the right and left in the lower overall signal section. You can also move it to the side with the mouse in the center of the zoom window (four-sided arrow).
- 9 Select a chart type: measurement values or video signal

The display shows how the adjustable measurement task (target material), peak selection and possible interfering signals due to reflections or similar affect the video signal. There is no linear relationship between the position of the peak in the video signal display and the output measured value.

6.3 Parameter Setting via PROFINET

The ILD1900-x-PROFINET can be parameterized acyclically via records.

An overview of the available records can be found in the parameter documentation, see Chap. [8.5.3](#).

6.4 Timing, Measurement Value Cycles

The sensor needs five internal cycles for measuring and processing: The measurement value N is transmitted to the IO-Controller in the fifth cycle.

Measurement, processing and transmission take place in parallel, so that the next measurement value (N+1) is transmitted in the following cycle.

6.5 Operation via Membrane Key

You can restore the factory setting with the `Select` button.

Reset to factory setting does not change

- the IP address,
- the PROFINET name.

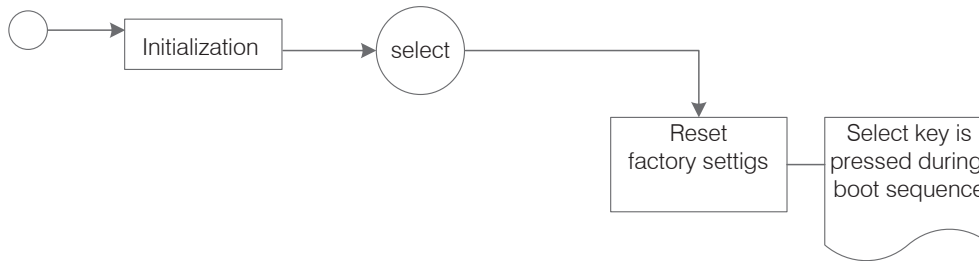

Fig. 24 Process: calling up the factory settings via `Select` button

7. Setting Sensor Parameters via Web Interface

7.1 Preliminary Remarks about the Setting Options

There are two ways to parameterize the optoNCDT 1900:

- via web browser and sensor web interface,
- by means of PROFINET and the manufacturer-specific records, see Chap. 8.5.3.

i

If you do not permanently save the parameter set in the sensor, the settings are lost when the sensor is turned off.

After completing the settings in the web interface:

➡ Go to `Settings > System settings > Load & Save` or click the `Save settings` button, see Chap. 7.7.3.

The sensor also saves the settings to the records for use in PROFINET operation.

7.2 Parameters Overview

The following parameters can be set or changed in the optoNCDT 1900, see `Settings` tab.

Inputs	Laser power
Data recording	Measurement task, measuring rate, evaluation range, exposure mode, peak selection
Signal processing	Averaged measurement 1/2, zeroing/mastering
System settings	Web interface unit, Load & Save, Import & Export, Reset sensor (factory setting)

Fig. 25 Menu structure web interface, tab `Settings`

7.3 Inputs

➤ Change to the `Inputs` menu in the `Settings` tab.

Laser power	<i>Full</i>	<i>Full power for standard surfaces</i>	<i>The laser light source is only enabled if pin 7 is connected to pin 8, see Chap. 5.4.5.</i>
	<i>Medium</i>	<i>Optimized power for strongly reflecting surfaces and small measuring ranges</i>	
	<i>Reduced</i>	<i>Min. power for service purposes</i>	
	<i>Off</i>	<i>Laser is off</i>	

i Pay attention to the signal intensity when switching the laser power. You achieve best possible results with a signal intensity of 25 ... 50 %.

 Fields with gray background require a selection.

 *Value* Fields with dark border require entry of a value

7.4 Data Recording

7.4.1 Preliminary Remarks

➤ On the **Settings** tab, switch to the **Data recording** menu.

According to the previous setting in the **Chart type** area, a graph is displayed in the right part of the display. The diagram is active and all settings become immediately visible. Notes on the chosen settings are displayed below.

In the left area, the **Data recording** menus are displayed.

7.4.2 Measurement Configuration

For further details, see Chap. 6.2.3.

7.4.3 Measuring Rate

The measuring rate indicates the number of measurements per second.

➤ Select the required measuring rate.

Measuring rate	250 Hz / 500 Hz / 1 kHz / 2 kHz / 4 kHz / 8 kHz / 10 kHz	Use a high measuring rate for bright and mat measuring objects. Use a low measuring rate for dark or shiny measuring objects (e.g. black painted surfaces) to improve the measurement result. The max. measuring rate depends on PROFINET and the bus cycle time.
	free measuring rate	

At a maximum measuring rate of 10 kHz, the CMOS element is exposed 10,000 times per second. The lower the measuring rate, the longer the maximum exposure time.

The measuring rate is factory set to 4 kHz.

7.4.4 Reset Counter

You can reset the counter readings for the measured values and time stamps. It is not possible to display the counter readings in the web interface.

 Fields with gray background require a selection.

 Value Fields with dark border require entry of a value

7.4.5 ROI Masking

Masking limits the evaluating range (ROI - Region of Interest) for the distance calculation in the video signal. This function is used in order to e.g. suppress interfering reflections or ambient light.

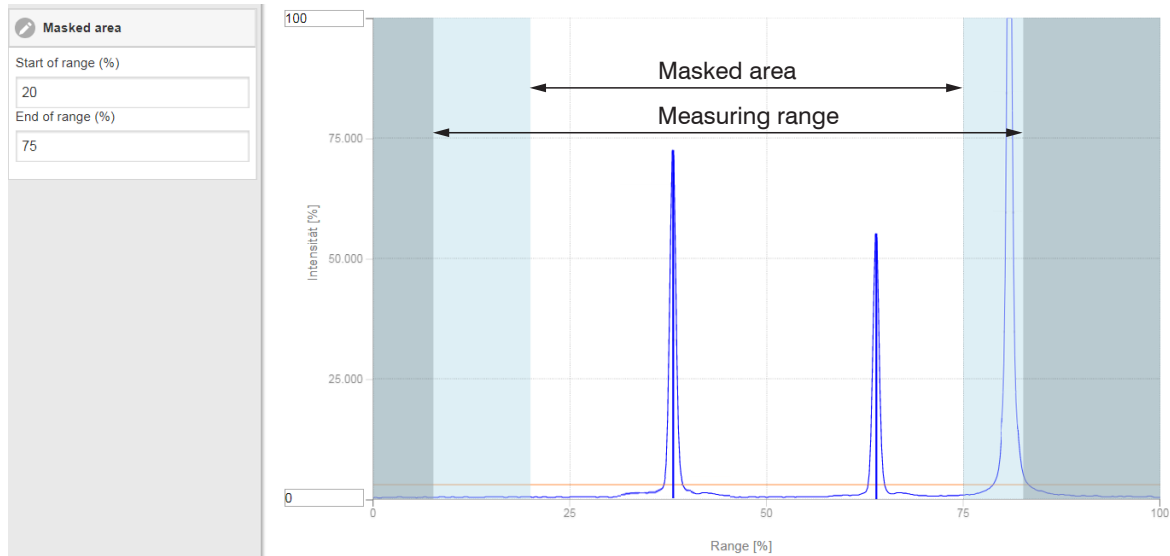



Fig. 26 Light-blue areas delimit the region of interest

The exposure control optimizes the peaks in the evaluation range. Therefore, small peaks can be optimally adjusted when a high interference peak is outside the evaluation range.

 Fields with gray background require a selection.

 *Value* Fields with dark border require entry of a value

7.4.6 Exposure Mode

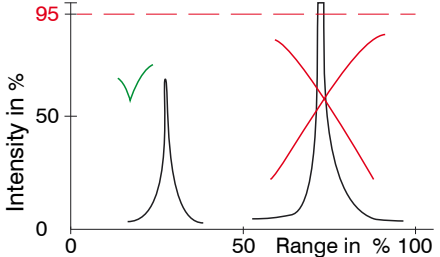
Exposure mode	<i>Automatic mode</i>		<i>Standard / Intelligent control / Background suppression</i>	 <p><i>Standard: The sensor itself determines the optimal exposure time. The sensor adjusts the signal intensity to approx. 50%.</i></p> <p><i>Intelligent control: This intelligent algorithm is particularly advantageous for measurements on moving objects or in the case of transitions between different materials.</i></p> <p><i>Background suppression: Suppresses interference caused by ambient light. This significantly improves the ambient light tolerance of the sensor. The output rate of the sensor is halved.</i></p>
	<i>Manuel mode</i>	Exposure time in μs	Value	<i>In manual mode, with the video signal shown, the exposure time is set by the user. Vary the exposure time in order to obtain a signal intensity of up to 95%.</i>

 Fields with gray background require a selection.

 Value Fields with dark border require entry of a value

7.4.7 Peak Selection

Peak selection	<i>First Peak / Highest Peak / Last Peak / Widest Peak</i>	<p><i>Defines which signal in the array signal is used for the evaluation.</i></p> <p><i>First peak: Nearest peak to sensor.</i></p> <p><i>Highest peak: Standard, peak with the highest intensity.</i></p> <p><i>Last peak: Peak furthest away from sensor.</i></p> <p><i>Largest peak: Peak with the largest surface.</i></p>	
----------------	--	---	--

If a measuring object contains multiple transparent layers, a correct measurement result is determined only for the first peak.



Fields with gray background require a selection.



Value Fields with dark border require entry of a value

7.5 Signal Processing

7.5.1 Preliminary Remarks

► Change to the `Signal processing` menu in the `Settings` tab.

According to the previous setting in the `Chart type` area, a graph is displayed in the right part of the display. The graph is active and all settings become immediately visible. Notes on the chosen settings are displayed below.

In the left area, the `Signal processing` menus are displayed.

7.5.2 Averaging

7.5.2.1 General

Averaging is recommended for static measurements or slowly changing measurement values. The `Averaging 1` function is executed before the `Averaging 2` function.

Measurement averaging	<i>No averaging</i>			<i>No measurement value averaging.</i>
	<i>Moving N values</i>	2 / 4 / 8 ... 4096	Value	<i>Specify the type of averaging. The averaging number N indicates how many consecutive values are averaged in the sensor.</i>
	<i>Recursive N values</i>	2 ... 32767	Value	
	<i>Median N values</i>	3 / 5 / 7 / 9	Value	

Measurement averaging is performed after the distance values have been calculated, and before they are issued through the relevant interfaces.

Averaging

- improves the resolution,
- allows masking individual interference points or
- "smoothes" the measurement result.

Linearity is not affected by averaging.

The average values are continuously recalculated with each measurement. The desired averaging depth is only achieved after the number of recorded measurement values corresponds at least to the averaging depth.

 Fields with gray background require a selection.

 Value Fields with dark border require entry of a value

i The defined type of average value and the averaging number must be stored in the sensor so that they are retained after switching off.

Averaging has no effect on the measuring rate or data rate in case of digital measurement value output. The averaging numbers can also be programmed via the digital interfaces. The optoNCDT 1900 sensor is delivered with “Median 9” as factory settings, i.e. median averaging over 9 measurement values.

Depending on the type of average and the number of averaged values, different transition response times result thereof, see Chap. 6.4.

7.5.2.2 Moving Average

The definable number N for successive measurements (window width) is used to calculate the arithmetic average M_{mov} according to the following formula:

$$M_{\text{mov}} = \frac{\sum_{k=1}^N MV(k)}{N}$$

MV	Measurement value,
N	Averaging number,
k	Running index
M_{mov}	Averaging value or output value

Method:

Each new measured value is added, the first (oldest) measured value is removed from the averaging (from the window) again. In this way, it is possible to achieve short transition response times with measured value jumps.

Example: $N = 4$

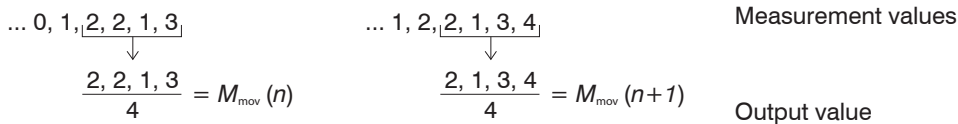

Note:

For the moving averaging in the optoNCDT 1900, only powers of 2 are permitted for the averaging number N . Range of values for the averaging number N is 1 / 2 / 4 / 8 ... 4096.

7.5.2.3 Recursive Average

Formula:

$$M_{\text{rec}}(n) = \frac{MV_{(n)} + (N-1) \times M_{\text{rec}(n-1)}}{N}$$

MV Measurement value,
 N Averaging number,
 n Measurement value index
 M_{rec} Averaging value or output value

Method:

The weighted value of each new measured value $MV(n)$ is added to the sum of the previous average values $M_{\text{rec}}(n-1)$.

Note:

Recursive averaging enables very strong smoothing of the measured values, however it needs very long settling times for measured value jumps. The recursive average value shows low-pass behavior. The range of values for the averaging number N is 2 ... 32767.

7.5.2.4 Median

A median value is formed from a preselected number of measurements.

Methods:

The incoming measured values (3, 5, 7 or 9 measurement values) are also sorted again after each measurement. The median value is then output as the median. 3, 5, 7 or 9 measured values are taken into account for the calculation of the median, i.e. there is no median 1.

Note:

This averaging type suppresses individual interference pulses. However, the smoothing of the measured value curves is not very strong.

Example: mean value from five readings

... 0 1 2 4 5 1 3 → Sorted measurement values: 1 2 3 4 5 Median $_{(n)} = 3$

... 1 2 4 5 1 3 5 → Sorted measurement values: 1 3 4 5 5 Median $_{(n+1)} = 4$

7.5.3 Zeroing, Mastering

The screenshot shows the 'Zeroing/Mastering' configuration page. It includes a dropdown menu for 'Master signal' (set to 'Distance 1'), a text input for 'Master value in mm' (set to '2'), and buttons for 'Apply master signal', 'Delete master signal', 'Select master signal' (set to 'All'), 'Activate master value', and 'Reset master value'. Red lines with numbers 1 through 6 point to these elements: 1 points to the 'Distance 1' dropdown, 2 to the 'Apply master signal' button, 3 to the 'Delete master signal' button, 4 to the 'All' dropdown, 5 to the 'Activate master value' button, and 6 to the 'Reset master value' button.

Use zeroing and setting masters to define a target value within the measuring range. This shifts the output range. This feature can be useful, for example, when several sensors carry out thickness and planarity measurements when placed next to one another or when replacing a sensor.

Mastering (setting masters) is used to compensate for mechanical tolerances in the sensor measurement setup or to correct chronological (thermal) changes to the measuring system. The master value, also called calibration value, is defined as the target value.

The master value is the reading that is issued as result of measuring a master object. Zeroing is when you set a master with 0 (zero) as the master value.

i Mastering or Zeroing requires a target object to be present in the measuring range.

Mastering or Zeroing equally influences the digital output and the display.

- 1 Selects a signal for the function, assigns master value
- 2 Saves master value in volatile memory. ¹
- 3 Deletes master value in volatile memory.
- 4 Selects a specific signal or function
- 5 Starts function
- 6 Ends function, returns to absolute measurement

Mastering / Zeroing:

➡ Place target and sensor into the desired positions.

➡ Send the `Enable master` command (PROFINET) or click the `Activate master value` button.

After setting the master, the controller will issue new readings that relate to the master value. The `Reset master value` button resets the system to the state before mastering.

1) The `Save settings` function permanently saves the master value to a setup.

7.6 PROFINET Digital Values

7.6.1 Values, Ranges

The digital measurement values are issued as unsigned digital values (raw values). 16 or 18 bits can be transferred per value. Below you will find a compilation of the output values and the conversion of the digital value.

Value	Length	Variables	Value range	Formula
Distance	18 Bit	<i>x</i> Digital value	[0; 230604]	$d = \frac{x - 98232}{65536} * MR$
		<i>MR</i> Measuring range in mm	{2/6/10/25/50/100/200/500}	
		<i>d</i> Distance in mm	without mastering [-0.01 <i>MR</i> ; 1.01 <i>MR</i>] with mastering [-2 <i>MR</i> ; 2 <i>MR</i>]	
Exposure time	16 Bit	<i>x</i> Digital value	[1000; 40000]	$ET = \frac{1}{10} x$
		<i>ET</i> Exposure time in μ s	[100; 4000]	
Intensity	16 Bit	<i>x</i> Digital value	[0; 1023]	$I = \frac{100}{1023} x$
		<i>I</i> Intensity in %	[0; 100]	
Sensor status	18 Bit	<i>x</i> Digital value	[0; 242143]	Bit 0 (LSB): Peak starts before ROI
		Bit coding	[0; 1]	Bit 1: Peak ends after ROI
				Bit 2: No peak found
		<i>SMR</i> Start of measuring range		Bit 5: Distance before <i>SMR</i> (extended)
		<i>EMR</i> End of measuring range		Bit 6: Distance after <i>EMR</i> (extended)
Measured value counter	18 Bit	<i>x</i> Digital value	[0; 262143]	

Timestamp	32 Bit	x	Digital value	[0; 4294967295]	$t = \frac{1}{1000} x$
		t	Time stamp in μ s	[0; 1h11m34.967s]	
Unlinearized center of gravity	18 Bit	x	Digital value	[0; 262143]	$US = \frac{100}{262143} x$
		CG	Center of gravity in %	[0; 100]	
Measurement frequency	18 Bit	x	Digital value	[2500; 100000]	$f = \frac{x}{10}$
		f	Frequency in Hz		

State information transferred in the distance value

Distance value	Description
262076	There is no peak present
262077	Peak is before measuring range (MR)
262078	Peak is after measuring range (MR)
262080	Measurement value cannot be evaluated
262081	Peak is too wide
262082	Laser is off

i The sensor sends the cyclic process data in little-endian format. The acyclic requirements data is also in little-endian format; records are read as little-endian and must also be written as little-endian. If the PLC uses the big-endian format, the byte order must be swapped.

7.6.2 Behavior of the Distance Values

Master values based on the zeroing or master function are coded with 18 bits. The master can assume twice the measuring range. The examples demonstrate the behavior of the digital value with an ILD1900-100-IE, measuring range 100 mm.

Target with 16% of the measuring range

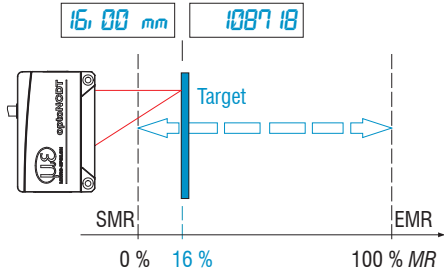

Target with 60% of the measuring range

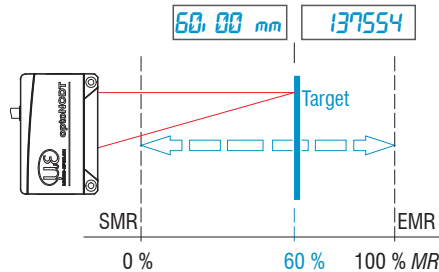

Target with 60% of the measuring range

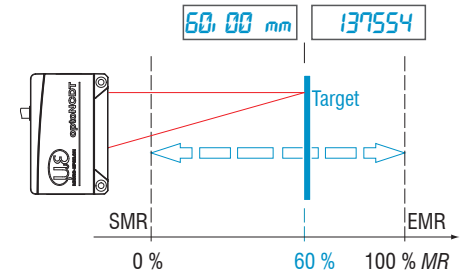

➡ Zero setting (master value = 0 mm)

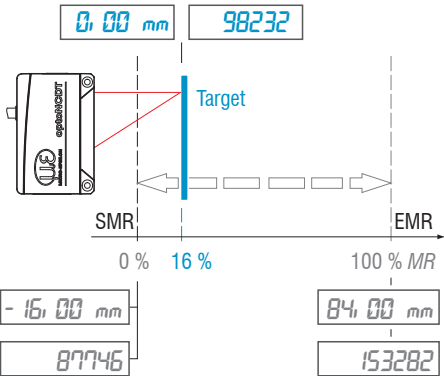

➡ Zero setting (master value = 0 mm)

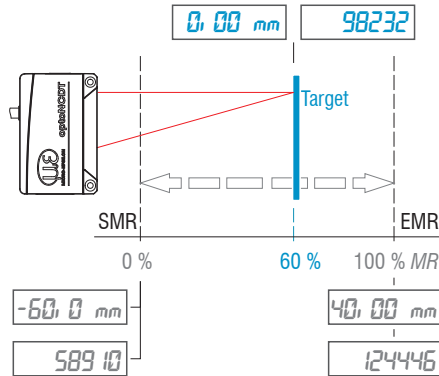

➡ Setting master value 10 mm

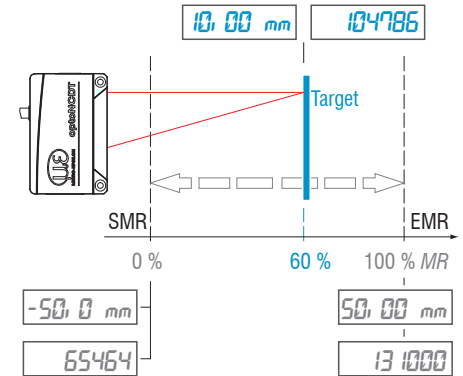

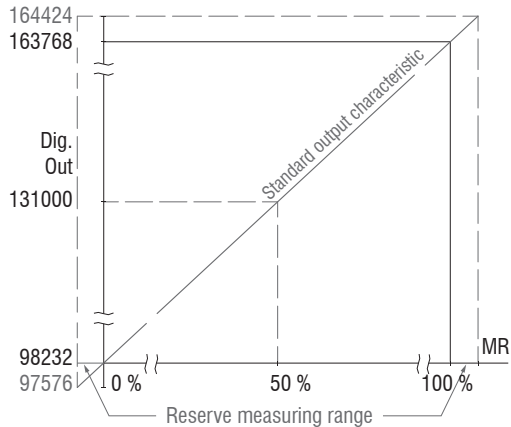

Fig. 27 Digital values without zeroing or mastering
optoNCDT 1900 / PROFINET

Target with 80% of the measuring range (80 mm)

➡ Setting master value 200 mm

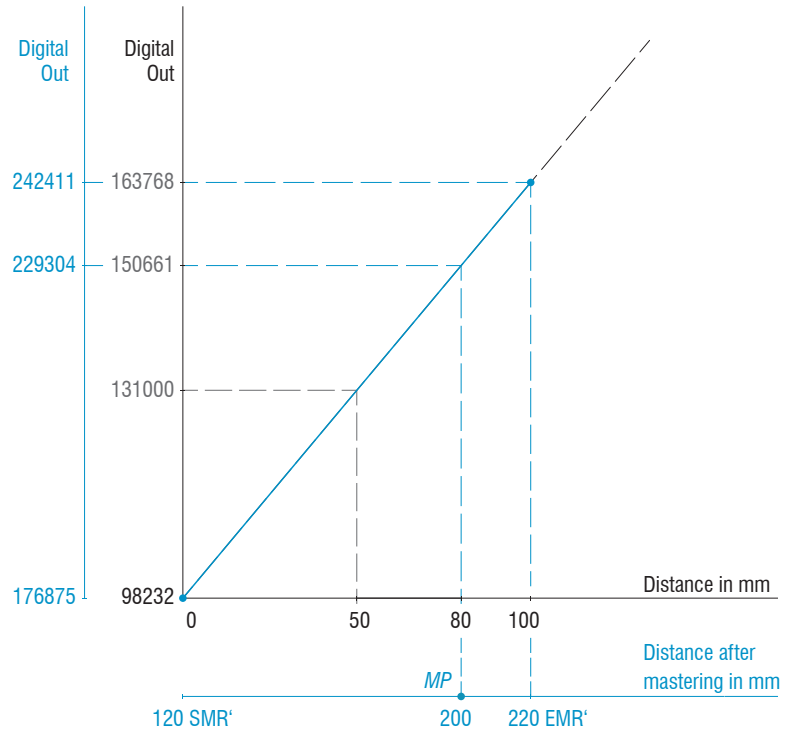

Fig. 28 Digital values 1900-100-IE after mastering with 200 mm master value

7.7 System Settings

7.7.1 General

After programming, save all settings permanently to a parameter set so that they will be available again the next time you switch on the sensor.

7.7.2 Unit, Language

The web interface promotes the units millimeter (mm) and inch when displaying measuring results. You can choose German or English in the web interface and change the language in the menu bar.

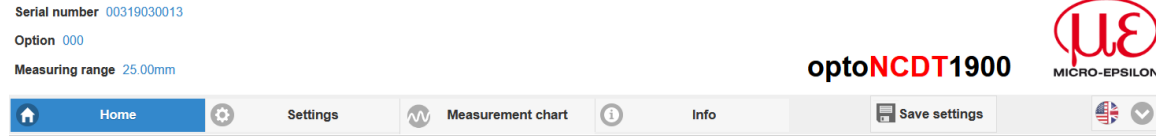
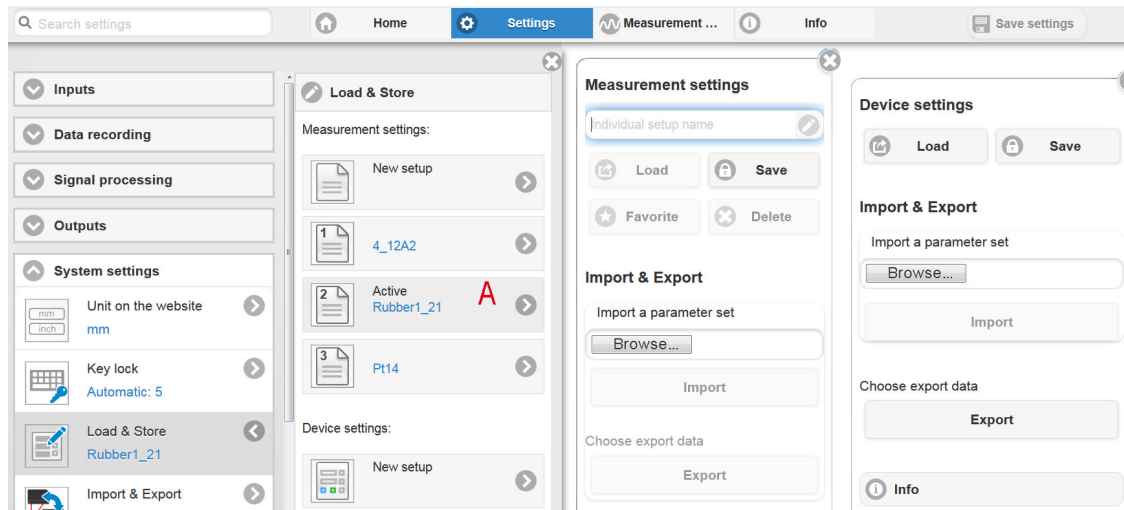

Fig. 29 Language selection in the menu bar

7.7.3 Load & Save

All sensor settings can be permanently saved in user programs, so-called setups, in the sensor.



For details about measurement and device settings, please refer to the section reset sensor, see Chap. 7.7.5.

Fig. 30 Managing user settings

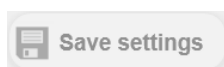
How to manage the sensor settings, options			
Saving the settings	Activating existing setup	Saving changes in active setup	Defining setup after booting
New setup menu	Load & Save menu	Menu bar	Load & Save menu
<p>➡ Enter the name for the setup into field</p> <p><input type="text" value="Individual setup name"/></p> <p>e.g. Rubber_1_21 and click the Save button.</p>	<p>➡ Click on the desired setup with the left mouse button, area A.</p> <p>The Measurement settings dialog opens.</p> <p>➡ Click the Load button.</p>	<p>➡ Click the</p> <p> Save settings button.</p>	<p>➡ Click on the desired setup with the left mouse button, area A.</p> <p>The Measurement settings dialog opens.</p> <p>➡ Click the Favorite button.</p>

How to exchange setups with PC/notebook, options	
Saving setup on PC	Loading setup from PC
Load & Save menu	Load & Save menu
<p>➡ Click on the desired setup with the left mouse button, area A.</p> <p>The Measurement settings dialog opens.</p> <p>➡ Click Export.</p>	<p>➡ Left-click on New setup.</p> <p>The Measurement settings dialog opens.</p> <p>➡ Click Search.</p> <p>A Windows dialog for file selection opens.</p> <p>➡ Choose the desired file and click the Open button.</p> <p>➡ Click the Import button.</p>

7.7.4 Import, Export

A parameter set includes the current settings, setup(s) and the initial setup when booting the sensor. The `Import` & `Export` menu enables easy exchange of parameter sets with a PC/notebook.

How to exchange parameter sets with PC/notebook, options	
Storing parameter set on PC	Loading parameter set from PC
Import & Export menu	Import & Export menu
<p>➡ Left-click on the <code>Create a parameter set</code> button.</p> <p>The dialog <code>Choose export data</code> opens.</p> <p>➡ Compose a parameter set by checking/unchecking the checkboxes.</p> <p>➡ Click the <code>Transmit file</code> button.</p> <p>A Windows dialog for data transfer opens.</p> <p>➡ Confirm the dialog with <code>OK</code>.</p> <p>The operating system files the parameter set in <code>Download</code>. The file name for the adjacent example is <code><...\Downloads\ILD1900_BASIC-SETTINGS_MEASSETTINGS_... .JSON></code></p>	<p>➡ Click <code>Search</code>.</p> <p>A Windows dialog for file selection opens.</p> <p>➡ Choose the desired file and click on the button <code>Open</code>.</p> <p>The dialog <code>Choose import data</code> opens.</p> <p>➡ Select the operations to be performed by checking/unchecking the checkboxes.</p> <p>➡ Click the <code>Transmit file</code> button.</p>

✕

Choose export data

Settings

`4_12A2`

`Rubber1_21`

`Pt14`

Initial Setup at booting

`Rubber1_21`

General Sensor settings

`General Sensor settings`

Transmit file

In order to avoid that an already existing setup is overwritten unintentionally during import, an automatic security request is carried out, see adjacent figure.

Options during import

- `Overwrite existing setups (with the same name)`
- `Apply settings of the imported initial setup`

7.7.5 Reset Sensor

Reset sensor	Device settings	<i>Button</i>	<i>Clears the settings for baud rate, language, unit, key lock and echo mode and loads the default parameters.</i>
	Measurement setting	<i>Button</i>	<i>Clears the settings for measuring rate, evaluation range, peak selection, error handling, averaging, zeroing/mastering, data reduction and setups. Loads the 1st preset.</i>
	Reset all	<i>Button</i>	<i>Clears the sensor settings, measurement settings, access authorization, password and setups. Loads the 1st preset.</i>
	Reboot sensor	<i>Button</i>	<i>Reboots the sensor with the settings from the favorite setup, see Chap. 7.7.4.</i>

7.7.6 Bootmode

- Industrial Ethernet: The sensor starts or changes to the regular PROFINET operation.

 Save your settings when you have finished programming, see Chap. [7.7.3](#).

The sensor must have an IP address so that the web interface and the PLC can access the sensor **in** parallel via Ethernet (TCP/IP and UDP protocols).

 Fields with gray background require a selection.

 *Value* Fields with dark border require entry of a value

8. PROFINET Documentation

8.1 Preliminary Remarks

The sensor starts with the last stored operating mode. Standard is PROFINET.

PROFINET operation enables easy parameter setting of a sensor

- via web interface, see Chap. 6.2.1, see Chap. 7.
- Records, see Chap. 8.5.3.

8.2 General, Initial Operation

The ILD1900-x-IE with PROFINET is a PROFINET IO device that can exchange data cyclically and acyclically with a PROFINET IO controller. The sensor supports PROFINET with RT (Real-Time Communication). PROFINET IRT (Isochronous Real-Time Communication) is currently not supported.

Maximum measurement frequency (RT)	10 kHz (via oversampling)
Minimum bus cycle period (RT)	1 ms
Supported I&M records	0 to 3
Minimum cyclic process data size	4 bytes
Maximum cyclic process data size	288 bytes
Number of input modules	8
Number of input submodules	48

In the delivery state, the ILD1900-x-IE with PROFINET has no IP address and also no device name. These settings must be made once. The IP address and the device name are assigned via the PROFINET Discovery Protocol. The IP address and the device name can be assigned, e.g., via the `TIA Portal` software.

i To use the ILD1900-x-IE with PROFINET, you need the GSDML file associated with the sensor. This is an XML file that you must include in your PLC environment, see Chap. 8.6.

i Define the modules in the device overview, see Chap. 8.7. Refer to the notes and examples for acyclic reading and writing of records, see Chap. 8.8.

8.3 Cyclic Data Traffic

With RT operation, the ILD1900-x-IE with PROFINET achieves a minimum bus cycle time of 1 ms. With RT operation, the sensor measures at the internal measuring rate.

In PROFINET, the structure of the process data is defined by the modules and submodules. Modules can be placed in slots and submodules in subslots. When a submodule is placed in a subslot, the parameters of the submodule are selected for cyclic process data transfer. A submodule contains at least one parameter..

The ILD1900-x-IE with PROFINET dynamically adapts to the module configuration that you have made in the PLC. You can reconfigure the module by rebooting the sensor.

The ILD1900-x-IE with PROFINET

- defines 8 different input modules
- each containing 6 submodules.

The 8 input modules can only be placed in slot 1, which means that only one module can be selected at a time. When choosing an input module you decide for a kind of oversampling. Oversampling 1 to 8 are available for selection. Oversampling is a mechanism that allows you to have the sensor measure faster than the bus cycle. Process data is collected in the sensor over several measurement cycles and written to the process data frame one after the other. With oversampling, a process data frame thus contains the same parameter several times from different measurement cycles. With an oversampling of, e.g. 3, the process data frame contains each parameter of a submodule 3 times >>Verweis. The further forward a parameter is in the process data frame, the older the parameter is in time. With RT operation, it is therefore possible with oversampling to have the sensor measure at a maximum measurement frequency of 10 kHz, although the sensor itself only supports bus cycles of 1 kHz.

Name of input module	Number of submodules	Oversampling	Size of process data in bytes
Oversampling 1 Input	6	1	4 to 36
Oversampling 2 Input	6	2	8 to 72
Oversampling 3 Input	6	3	12 to 108
Oversampling 4 Input	6	4	16 to 144
Oversampling 5 Input	6	5	20 to 180
Oversampling 6 Input	6	6	24 to 216
Oversampling 7 Input	6	7	28 to 252
Oversampling 8 Input	6	8	32 to 288

Fig. 31 Input modules available for selection

You must select at least 1 submodule per module. The submodules can be placed anywhere in subslot 1 to 6. If you select a submodule with a larger oversampling than 1, the parameters of a submodule are transmitted several times in succession.

With an oversampling of 2, this means, for example, that for the `Frequency + Shutter` submodule, the frequency from the previous measuring cycle is transmitted in bytes 0 to 3 and the frequency from the current measuring cycle is transmitted in bytes 4 to 7.

Submodule, name	Parameter	Size of process data in bytes
Frequency + shutter	UINT32 Frequency UINT32 Exposure time	8
Frame time stamp	UINT32 Time stamp	4
Frame count	UINT32 Measured value counter	4
Frame status	UINT32 Status	4
Ulin + Intensity + Lin	UINT32 Unlinearized distance UINT32 Intensity UINT32 Linearized distance	12
Peak 1 distance	UINT32 Peak distance	4

Fig. 32 Oversampling 1 Input, submodules available for selection

Submodule, name	Parameter	Size of process data in bytes
Frequency + shutter	UINT32 Frequency 0 / 1 UINT32 Exposure time 0 / 1	16
Frame time stamp	UINT32 Time stamp 0 / 1	8
Frame count	UINT32 Measured value counter 0 / 1	8
Frame status	UINT32 Status 0 / 1	8
Ulin + Intensity + Lin	UINT32 Unlinearized distance 0 / 1 UINT32 Intensity 0 / 1 UINT32 Linearized distance 0 / 1	24
Peak 1 distance	UINT32 Peak distance 0 / 1	8

Fig. 33 Oversampling 2 Input, submodules available for selection

Submodule, name	Parameter	Size of process data in bytes
Frequency + shutter	UINT32 Frequency 0 / 1 / 2 UINT32 Exposure time 0 / 1 / 2	24
Frame time stamp	UINT32 Time stamp 0 / 1 / 2	12
Frame count	UINT32 Measured value counter 0 / 1 / 2	12
Frame status	UINT32 Status 0 / 1 / 2	12
Ulin + Intensity + Lin	UINT32 Unlinearized distance 0 / 1 / 2 UINT32 Intensity 0 / 1 / 2 UINT32 Linearized distance 0 / 1 / 2	36
Peak 1 distance	UINT32 Peak distance 0 / 1 / 2	12

Fig. 34 Oversampling 3 Input, submodules available for selection

Submodule, name	Parameter	Size of process data in bytes
Frequency + shutter	UINT32 Frequency 0 / 1 / 2 / 3 / 4 / 5 / 6 / 7 UINT32 Exposure time 0 / 1 / 2 / 3 / 4 / 5 / 6 / 7	64
Frame time stamp	UINT32 Time stamp 0 / 1 / 2 / 3 / 4 / 5 / 6 / 7	32
Frame count	UINT32 Measured value counter 0 / 1 / 2 / 3 / 4 / 5 / 6 / 7	32
Frame status	UINT32 Status 0 / 1 / 2 / 3 / 4 / 5 / 6 / 7	32
Ulin + Intensity + Lin	UINT32 Unlinearized distance 0 / 1 / 2 / 3 / 4 / 5 / 6 / 7 UINT32 Intensity 0 / 1 / 2 / 3 / 4 / 5 / 6 / 7 UINT32 Linearized distance 0 / 1 / 2 / 3 / 4 / 5 / 6 / 7	96
Peak 1 distance	UINT32 Peak distance 0 / 1 / 2 / 3 / 4 / 5 / 6 / 7	32

Fig. 35 Oversampling 8 Input, submodules available for selection

The parameters and the respective sizes of the process data for an oversampling 4 to 7 are formed analogously to the mentioned schemes.

8.4 Data Format, Little-Endian

The sensor sends the cyclic process data in little-endian format.

The acyclic demand data is also in little-endian format; records are read as little-endian and must also be written as little-endian.

If the PLC uses the big-endian format, the byte order must be swapped.

AllenBradley	Big-endian
BECKHOFF	Big-endian
Festo	Little-endian
Omron	Big-endian
SIEMENS S7-300	Big-endian
SIEMENS S7-1200/150	Little-endian

Fig. 36 Data format, examples of some manufacturers

8.5 Acyclic Reading and Writing of Records

8.5.1 General

The ILD1900-x-IE with PROFINET can be parameterized via acyclic demand data that are not transmitted cyclically. These acyclic requirements data are organized in PROFINET in the so-called records.

A record is a contiguous block

- of one or more parameters,
- which can be accessed in read or write mode.

When writing or reading a record, you must fill the read or write request with AR, API, slot, subslot, index, and the read/write length.

8.5.2 I&M Records

PROFINET defines so-called `Identification` and `Maintenance Records`, which contain various device information. These records are available in every PROFINET device.

The read and write request is addressed as follows:

Parameter	Length in bytes	Value
AR	0	Permanently 0
API	4	Permanently 0
Slot	2	Permanently 0
Subslot	2	Permanently 1
Index	2	0xAFF0 – 0xAFF3
Length	4	see Block length

The ILD1900-x-IE with PROFINET supports the I&M records 0 to 3.

	Parameter	Data type	Info
Block Header	Block Type	UINT16	0x0020
	Block Length	UINT16	0x0038
	Block Version High	UINT8	0x01
	Block Version Low	UINT8	0x00
I&M0	Manufacturer ID	UINT16	0x0426 (MICRO-EPSILON Messtechnik GmbH)
	Order ID	UINT8(20)	„4120xxx.001“
	Serial Number	UINT8(16)	
	Hardware-Revision	UINT16	z. B. 0x0003
	Software-Revision Prefix	UINT8	Character describing the software of the (sub) module. Allowed values: 'V', 'R', 'P', 'U' and 'T'
	Software-Revision X	UINT8	Function Enhancement (Major Version Number)
	Software-Revision Y	UINT8	Bug Fix (Minor Version Number)
	Software-Revision Z	UINT8	Internal Change (Build Version Number)
	Revision Counter	UINT16	Starting from 0, shall increment on each parameter change
	Profile ID	UINT16	0
	Profile specific type	UINT16	5
	IM Version	UINT16	The I&M version. (Default value 0x0101)
	IM Supported	UINT16	Bit list describing the I&M variants supported by the (sub) module: 0x02 -> I&M1 Supported 0x04 -> I&M2 Supported 0x08 -> I&M3 Supported 0x10 -> I&M4 Supported 0x20 -> I&M5 Supported

Fig. 37 Struktur I&M0-Record, Index: 0xAFF0, Zugriff: Read-Only

	Parameter	Data type	Info
Block Header	Block Type	UINT16	0x0021
	Block Length	UINT16	0x0038
	Block Version High	UINT8	0x01
	Block Version Low	UINT8	0x00
I&M1	Function Tag	UINT8(32)	
	Location Tag	UINT8(22)	

Fig. 38 Structure I&M1 record, index: 0xAFF1, access: read-write

	Parameter	Data type	Info
Block Header	Block Type	UINT16	0x0022
	Block Length	UINT16	0x0012
	Block Version High	UINT8	0x01
	Block Version Low	UINT8	0x00
I&M2	Installation date	UINT8(16)	Installation date
	Reserviert	UINT8(38)	Reserved

Fig. 39 Structure I&M2 record, index: 0xAFF2, access: read-write

	Parameter	Data type	Info
Block Header	Block Type	UINT16	0x0023
	Block Length	UINT16	0x0038
	Block Version High	UINT8	0x01
	Block Version Low	UINT8	0x00
I&M3	Descriptor	UINT8(54)	Description text

Fig. 40 Structure I&M3 record, index: 0xAFF3, access: read-write

For more information about the I&M records, please visit
<https://www.profibus.com/download/PROFINET-specification>
 optoNCDT 1900 / PROFINET

8.5.3 Parameter Documentation

8.5.3.1 General

To configure parameters in the sensor, an additional addressing level, the parameter ID, is used. Each parameter has a unique parameter ID.

Via the parameter ID, starting from 50000, individual parameters such as the measuring rate in the sensor can be selected. To do this, you must first write the desired parameter ID in the 0x2000 records. After that you can read and write the parameter.

8.5.3.2 Licht Source

Inputs

Name	Parameter ID	Data type	Description	Access
Laser power	50500	UINT8	Switch laser on and off 0 - Off 1 - Full 2 - Reduced	rw

8.5.3.3 Measurement Configuration, Measuring Rate, Evaluation Range (ROI), Exposure, Peak Selection, Error Handling

Data recording

Name	Parameter ID	Data type	Description	Unit	Access
Measurement task	51000	UINT8	Measurement task, object properties 0 - Standard 2 - Penetration 1 - Multisurface		rw
Measuring rate	51002	FLOAT	Free measuring rate; 250 ... 10,000 Hz; Max. bus cycle 1 kHz, max. oversampling 8	Hz	rw
Start of range	51009	UINT16	Start of evaluation range	%	rw
End of range	51010	UINT16	End of evaluation range	%	rw
Shutter mode	51019	UINT8	Exposure mode, automatic or manual 0 - Manual 1 - Automatic		rw
Shutter value in μs	51020	FLOAT	Exposure time for manual mode; 1 ... 4000 μs	μs	rw
Exposure mode	51021	UINT8	Automatic exposure selection 0 - Standard 2 - Background 1 - Intelligent		rw
Peak selection	51029	UINT8	Peak selection video signal for distance calculation 0 - Highest peak 2 - Last peak 1 - Widest peak 3 - First peak		rw
Error handling type	51039	UINT8	Behavior of digital output in case of error 0 - None 2 - Infinite 1 - Value		rw
Error handling values	51040	UINT32	Hold value for 1 ... 1024 measuring cycles		rw

An example of a conversion for the measuring rate in the TIA Portal can be found in the section on float parameters, see [Fig. 47](#).

An example of an implementation for peak selection in the TIA Portal can be found in the section on integer parameters, see [Fig. 50](#).

8.5.3.4 Averaging

Signal processing

Name	Parameter ID	Data type	Description	Access
Comp1 type	52000	UINT8	Averaging type	rw
			0 - None 2 - Moving 1 - Median 3 - Recursive	
Average 1 number of values for moving average	52001	UINT32	Number of values over which the average is taken	rw
			2 - 2 ... 4 - 4 2048 - 2048 8 - 8 4096 - 4096	
Average 1 number of values for median	52002	UINT32	3 - 3 7 - 7 5 - 5 9 - 9	rw
Average 1 number of values for recursive	52003	UINT32	2 - 2 5 - 5 3 - 3 ... 4 - 4 32000 - 32000	rw
Comp2 type	52010	UINT8	Averaging type	rw
			0 - None 2 - Moving 1 - Median 3 - Recursive	
Average 2 number of values for moving average	52011	UINT32	Number of values over which the average is taken	rw
			2 - 2 ... 4 - 4 2048 - 2048 8 - 8 4096 - 4096	
Average 2 number of values for median	52012	UINT32	3 - 3 7 - 7 5 - 5 9 - 9	rw
Average 2 number of values for recursive	52013	UINT32	2 - 2 5 - 5 3 - 3 ... 4 - 4 32000 - 32000	rw

8.5.3.5 Zeroing, Mastering

Name	Parameter ID	Data type	Description	Access
Master enable	53001	BOOL	Determine signal DIST1 for zeroing/mastering 0 - False 1 - True	rw
Master set	53003	BOOL	Perform zeroing or mastering or terminate 0 - False 1 - True	rw
Master Value	53004	FLOAT	Specify the thickness (or other parameter) of a master object. Value range -2 to +2 x measuring range	rw

Setting masters/Zeroing – Step-by-Step:

- True for `Master enable` (53001) specifies that the function is applied to the DIST1 signal.
- Pass the value for zeroing/mastering to parameter 53004.
- Start zeroing or mastering with True for `Master set` (53003).

8.5.3.6 System Settings, Key Lock, Login, Password, Factory Settings

Name	Parameter ID	Data type	Description	Access
Key lock	54000	UINT8	Key lock <code>Select</code> button	
			0 - None 1 - Active	2 - Auto rw
Key lock time	54001	UINT8	For <code>Auto</code> function : after expiration, key lock sets; 1 ... 60 min	rw
Current user	54010	UINT8	User level query	
			1 - User	3 - Professional ro
Login	54011	STRING(32)	Password for a change to the Professional level	wo
Logout	54012	BOOL	Change to User level	
			0 - No	1 - Yes rw
Default user	54013	UINT8	Setting the user level after a restart of the sensor	
			0 - User	1 - Professional rw
Old password	54014	STRING(32)	Create and change password for the Professional level	wo
New password	54015	STRING(32)		wo
Repeat password	54016	STRING(32)		wo
Reset to factory measurement settings	54020	BOOL	Reset measurement settings	
			0 - False	1 - True wo
Reset to factory device settings	54021	BOOL	Reset device settings	
			0 - False	1 - True wo
Reset to factory all settings	54023	BOOL	Reset all	
			0 - False	1 - True wo
Reboot sensor	54024	BOOL	Reboot sensor	
			0 - False	1 - True wo

8.5.3.7 Load, Save Device Settings

Name	Parameter ID	Data type	Description	Access
Load	54500	BOOL	Loads the saved device settings from the sensor 0 - False 1 - True	wo
Save	54501	BOOL	Saves the current device settings in the sensor 0 - False 1 - True	wo

Details can also be found in the section Loading, Saving, see Chap. [7.7.3](#).

8.5.3.8 Load and Apply Presets

Name	Parameter ID	Data type	Description	Access
Mode	55000	UINT8	Returns the currently used preset mode (signal quality); with <Parameter> the preset mode (signal quality) to be used is set.	rw
			0 - None 1 - Static 2 - Balanced	
List	55001	STRING(230)	Lists all existing manufacturer-specific programs.	ro
Read	55002	STRING(32)	Loads and executes a preset< Name> for use in the sensor.	wo

8.5.3.9 Load, Save and Apply Setups

Name	Parameter ID	Data type	Description	Access
Current	55500	STRING(32)	Returns the name of the currently used preset or setup.	ro
Read	55501	STRING(32)	Loads and executes a setup <Name> for use in the sensor.	wo
Store	55502	STRING(32)	Saves the current user-specific settings to a Setup<name> or a new Setup <Name> is created in non-volatile memory.	wo
Delete	55503	STRING(32)	Deletes the associated setup<name>	wo
Initial	55504	STRING(32)	Returns the name of the setup intended for the next start of the sensor. With<name> a setup is determined, which will be used at the next start of the sensor. Presets cannot be indicated.	rw
List	55505	STRING(230)	Returns the names of all saved setups.	ro

8.5.3.10 Sensor Information

Name	Parameter ID	Data type	Description	Access
Measuring range	56000	FLOAT	Returns the measuring range of the sensor	ro
Option	56001	STRING32	Contains the option number of the sensor	ro

8.5.4 Acyclic Reading of the Cyclic Process Data (Index 0x6000)

The process data can also be read acyclically via the record with index 0x6000. The read request is addressed as follows:

Parameter	Length in bytes	Value
AR	0	Permanently 0
API	4	Permanently 0
Slot	2	Permanently 1
Subslot	2	Permanently 1
Index	2	0x6000
Length	4	4 ... 36 byte

Name	Data type	Access
Exposure time	UINT32	Read
Frequency	UINT32	Read
Time stamp	UINT32	Read
Measured value counter	UINT32	Read
Status	UINT32	Read
Unlinearized distance	UINT32	Read
Intensity	UINT32	Read
Linearized distance	UINT32	Read
Peak distance	UINT32	Read

The complete length of the record is 36 bytes. You do not have to read the full length of the record. If you specify a shorter length, it will stop from the end of the read length and you will receive only a part of the parameters.

Fig. 41 Record structure 0x6000

8.5.5 Parameter Records (Index 0x2000 – 0x2FFF)

8.5.5.1 General

It is possible to parameterize the sensor via the records 0x2000 to 0x2FFF.

The read/write request is addressed as follows:

Parameter	Length in bytes	Value
AR	0	Permanently 0
API	4	Permanently 0
Slot	2	Permanently 1
Subslot	2	Permanently 1
Index	2	0x2000 to 0x2FFF
Length	4	n bytes

0x2000 records are divided into subobjects. Each subobject is uniquely identified by a subindex. The reading of a 0x2000 record is always done from the beginning starting with subindex 0. All subobjects of a 0x2000 record are readable. A smaller part of a 0x2000 record is writable. For this purpose an additional header is coded into the user data of the write request, which makes it possible to address a single subindex within a 0x2000 record:

Name	Data type	Info
Padding	UINT16	Padding bytes
Subindex	UINT8	Subindex for addressing a single subobject in the record
Padding	UINT8	Padding bytes
Writing length	UINT32	Length to be written
Data	UINT8(n)	Data of the 0x2000 record to be written

Fig. 42 Parameter record structure

Reading 0x2000 records is done without the header.

8.5.5.2 Record Parameter Info 0x2501

The parameter info record can be used to read out metadata of a parameter. First, use the header to write the parameter ID to the record via subindex 1. After that you can read the record starting from subindex 0. The written parameter ID remains stored in the record. Restarting the sensor resets the parameter ID to the default parameter ID.

Subindex	Access	Data type	Name
0	Read	UINT8	Subindex 0
1	Read/Write	UINT16	Parameter ID
2	Read	STRING(14)	Name
3	Read	STRING(8)	Unit
4	Read	STRING(8)	Type

Fig. 43 Parameter info record 0x2501

8.5.5.3 Record Float Parameter 0x2510, Examples

Via this record float parameters of the sensor can be read and written. First, use the header to write the parameter ID to the record via subindex 1. Then you can write the float value to subindex 3 or read the complete record starting from subindex 0. The written parameter ID remains stored in the record. Restarting the sensor resets the parameter ID to the default parameter ID.

Subindex	Access	Data type	Name
0	Read	UINT8	Subindex 0
1	Read/Write	UINT16	Parameter ID
2	Read/Write	UINT8	Reserved
3	Read/Write	FLOAT	Float value
4	Read	STRING(14)	Name of the parameter
5	Read	STRING(8)	Unit of the parameter
6	Read	FLOAT	Reserved
7	Read	FLOAT	Reserved

Fig. 44 Float parameter record 0x2510

Example: Writing parameter ID in TIA Portal

- ▶ In the header, set the subindex to 1.
- ▶ Set the write length to 2 because the parameter ID is 2 bytes in size.

This is followed by 2 bytes of user data of the parameter ID you want to write. You can also write multiple subindexes at once by writing beyond the length of the subobject.

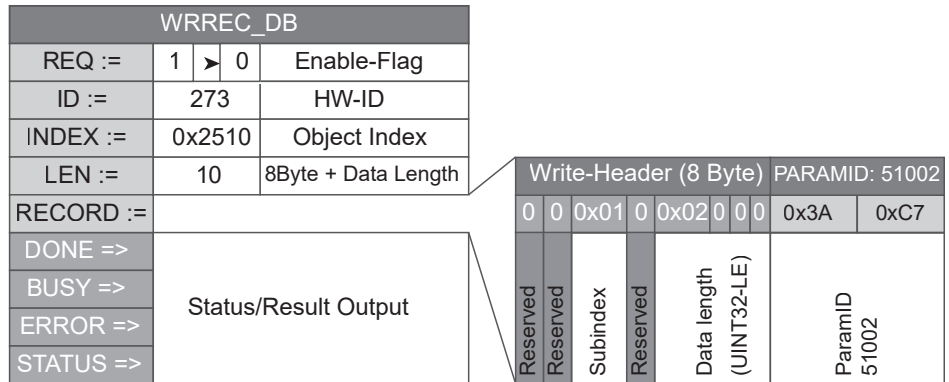

Example: Write float value to TIA Portal

➡ In the header, set the subindex to 3.

➡ Set the write length to 4 bytes (4 bytes float value)

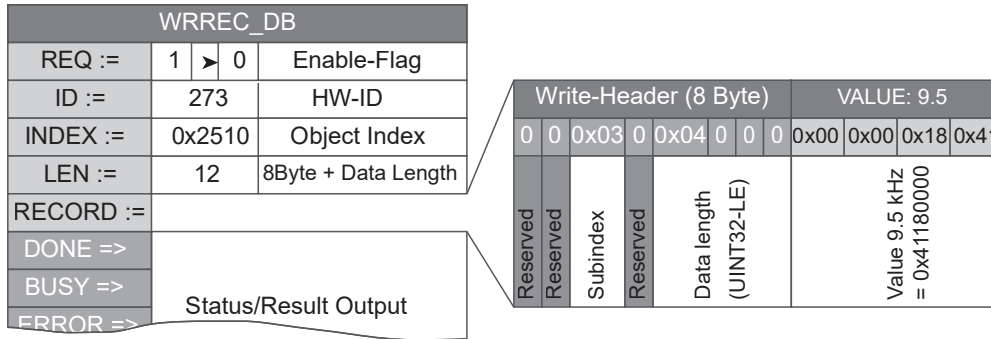

Fig. 45 PLC write command

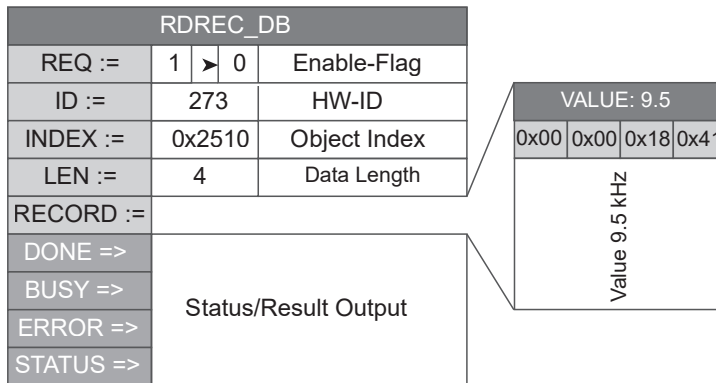

Fig. 46 PLC read command

Example: Writing parameter ID and float value in TIA Portal

You can also write subindex 1 to subindex 3 in a single write request to write parameter ID and float value.

- ➡ In the header, set the subindex to 1.
- ➡ Set the write length to 7 bytes

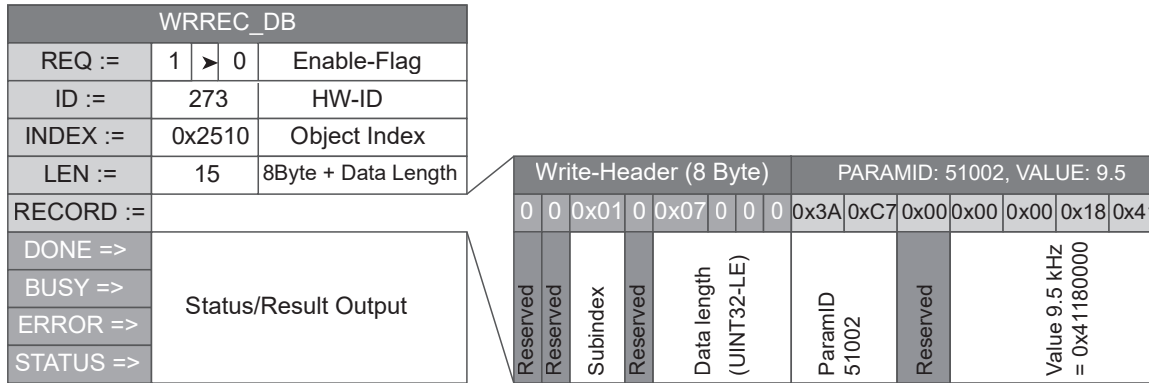

Fig. 47 Write command of the PLC to the sensor for a measuring rate of 9.5 kHz

8.5.5.4 Record Signed-Integer Parameter 0x2520

Via this record, parameters of type INT8, INT16 and INT32 can be read and written. First, use the header to write the parameter ID to the record via subindex 1. Then you can write the INT value to subindex 3 or read the complete record starting from subindex 0. You can also write subindex 1 to subindex 3 in a single write request to write parameter ID and INT value. The written parameter ID remains stored in the record. Restarting the sensor resets the parameter ID to the default parameter ID.

Subindex	Access	Data type	Name
0	Read	UINT8	Subindex 0
1	Read/Write	UINT16	Parameter ID
2	Read/Write	UINT8	Reserved
3	Read/Write	INT32	INT32 value
4	Read	STRING(14)	Name of the parameter
5	Read	STRING(8)	Unit of the parameter
6	Read	INT32	Reserved
7	Read	INT32	Reserved

Fig. 48 Signed integer parameter record 0x2520

8.5.5.5 Record Unsigned-Integer Parameter 0x2530, Example

Via this record, parameters of type UINT8, UINT16 and UINT32 can be read and written. First, use the header to write the parameter ID to the record via subindex 1. Then you can write the UINT value to subindex 3 or read the complete record starting from subindex 0. You can also write subindex 1 to subindex 3 in a single write request to write parameter ID and UINT value in one go. The written parameter ID remains stored in the record. Restarting the sensor resets the parameter ID to the default parameter ID.

Subindex	Access	Data type	Name
0	Read	UINT8	Subindex 0
1	Read/Write	UINT16	Parameter ID
2	Read/Write	UINT8	Reserved
3	Read/Write	UINT32	UINT32 value
4	Read	STRING(14)	Name of the parameter
5	Read	STRING(8)	Unit of the parameter
6	Read	UINT32	Reserved
7	Read	UINT32	Reserved

Fig. 49 Unsigned integer parameter record 0x2530

Example: Writing parameter ID and integer value with 8 bits in TIA Portal

- ➡ In the header, set the subindex to 1.
- ➡ Set the write length to 7 bytes

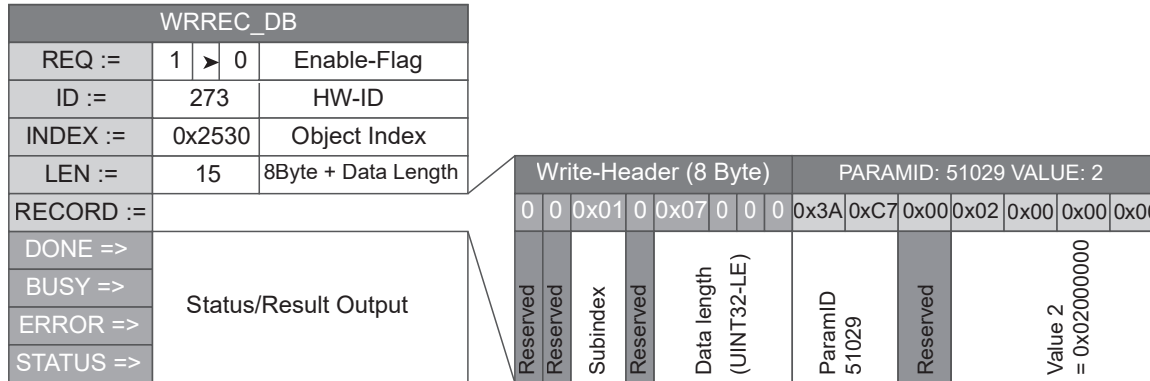

Fig. 50 Write command of the PLC to the sensor for “Last peak” in peak selection

8.5.5.6 Record String Parameter 0x2540

Parameters of type STRING are read and written via this record. First, use the header to write the parameter ID to the record via subindex 1. Then you can write the STRING value to subindex 3 or read the complete record starting from subindex 0. You can also write subindex 1 to subindex 3 in a single write request to write parameter ID and STRING value. The written parameter ID remains stored in the record. Restarting the sensor resets the parameter ID to the default parameter ID.

When reading a string, the string is transferred in the maximum possible length of 246 bytes. When writing you do not have to write the full 246 bytes, if the string is shorter you can limit it by the write length in the header.

Subindex	Access	Data type	Name
0	Read	UINT8	Subindex 0
1	Read/Write	UINT16	Parameter ID
2	Read/Write	UINT8	Reserved
3	Read/Write	STRING(246)	String value
4	Read	STRING(14)	Name of the parameter

Fig. 51 String parameter record 0x2540

8.6 Installing the GSDML file

A PROFINET IO device is described by a GSDML file with XML structure.

- ➔ Add the GSDML of the ILD1900-x-IE with PROFINET via the menu `Options > Manage general station description files (GSD)`.

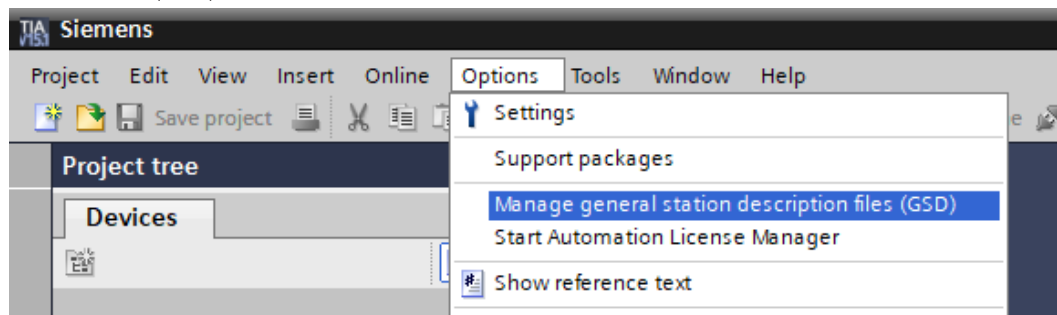

- ➔ Select the source path (1) and the desired XML file (2); confirm with the `Install` button (3).

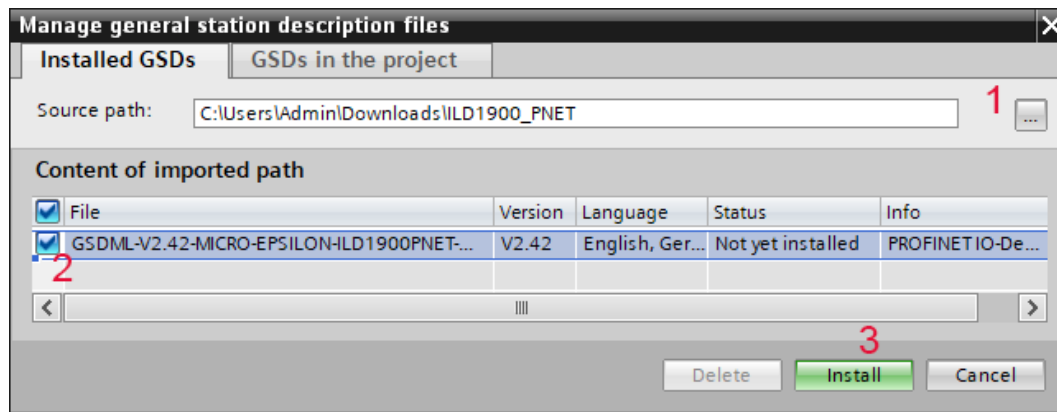

You can close the window after installing the GSDML file.

8.7 Configuring the Module

➔ Switch to the **Device overview** of the sensor and drag and drop an input module of your choice from the **Hardware catalog** into slot 1:

The screenshot shows the configuration software interface. The 'Device overview' table is as follows:

Module	Rack	Slot	I address	Q ad...	Type	Articl...
ild1900pnet	0	0			ILD1900/PNET	4120...
PN-IO	0	0 X1			ild1900pnet	
Oversampling 1 Input_1	0	1			Oversampling 1 Input	
	0	11				
	0	12				
	0	13				
	0	14				
	0	15				
	0	16				
	0	2				
	0	3				
	0	4				
	0	5				
	0	6				
	0	7				

The 'Hardware catalog' on the right shows the 'Oversampling 1 Input' module selected in the 'Input Modules' folder. A red arrow points from the catalog item to the slot 1 entry in the table.

Then place at least one **Submodule** in subslots 1 to 6.

➡ Drag and drop the submodule from the Hardware catalog into the subslots.

The screenshot shows the 'Hardware catalog' window with the 'Device overview' table and the 'Catalog' pane.

Module	Rack	Slot	I address	Q ad...	Type	Articl...
ild1900pnet	0	0			ILD1900/PNET	4120...
PN-IO	0	0 X1			ild1900pnet	
Oversampling 1 Input_1	0	1			Oversampling 1 Input	
Frame counter	0	11	101...104		Frame counter	
Frame status	0	12	105...108		Frame status	
Frame time stamp	0	13	109...112		Frame time stamp	
Frequency + Shutter	0	14	129...136		Frequency + Shutter	
Peak 1 distance	0	15	137...140		Peak 1 distance	
Unlin + Intensity + Lin	0	16	141...152		Unlin + Intensity + Lin	
	0	2				
	0	3				
	0	4				
	0	5				
	0	6				
	0	7				
	0	8				
	0	9				
	0	10				
	0	11				
	0	12				
	0	13				
	0	14				

The 'Catalog' pane shows the following structure:

- ▼ Catalog
 - Head module
 - Module
 - Input Modules
 - Oversampling 1 Input
 - Oversampling 2 Input
 - Oversampling 3 Input
 - Oversampling 4 Input
 - Oversampling 5 Input
 - Oversampling 6 Input
 - Oversampling 7 Input
 - Oversampling 8 Input
 - Submodules
 - Oversampling 1 Submodule
 - Frame counter
 - Frame status
 - Frame time stamp
 - Frequency + Shutter
 - Peak 1 distance
 - Unlin + Intensity + Lin

Each of your submodules has an address range. You can reference this address range in a watch table or a variable table, for example, to monitor or process the process data received from the sensor.

8.8 Acyclic Reading and Writing of Records via TIA-Portal

8.8.1 Sequence When Writing and Reading Acyclical Data

- ➔ Determine the hardware identification (ID) of the module.
To do this, switch to the `System constants` tab.

In the example to the right, you get the value 273.

On the SPS, `WRREC_DB` with input parameters (`:=`) is called.

`REQ // Start execution`

`ID // Hardware ID of the target device addressed`

`INDEX // Target address in the object directory`

`LEN // Length of the binary data block to be written`

`RECORD // Usable data for writing`

`RECORD`, `VALID`, `BUSY`, `ERROR`, `STATUS` and `LEN` contain return parameters (`=>`) that allow for determining the success or progress of the write command.

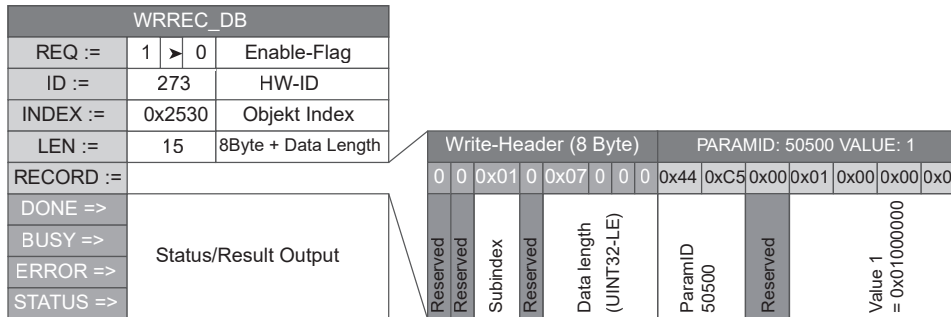
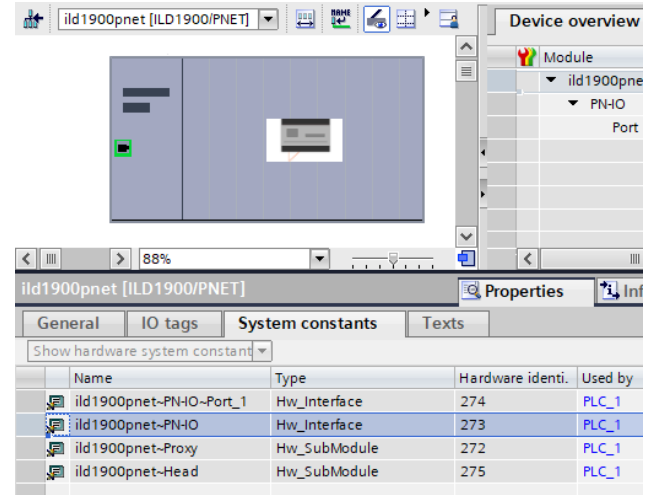

Fig. 52 PLC write command with 8 Byte prefix to turn on the laser light source on the sensor optoNCDT 1900 / PROFINET

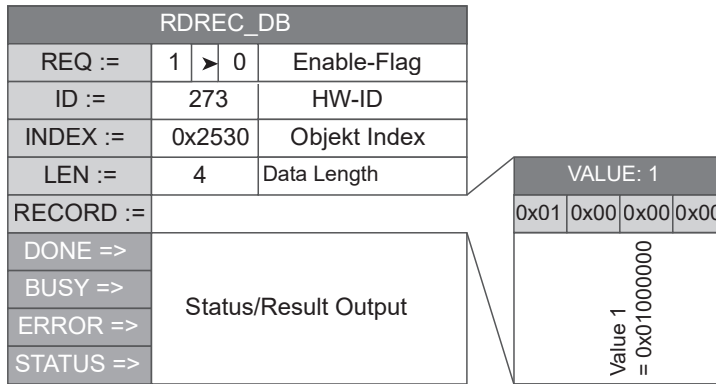

Fig. 53 PLC read command

The examples below show how to turn off the laser light source on the sensor.

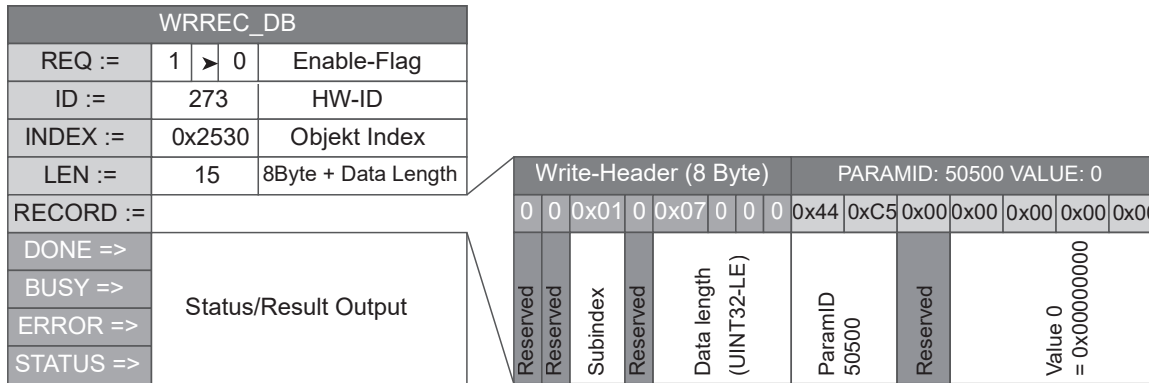

Fig. 54 SPS write command with 8 Byte prefix to turn off the laser light source on the sensor

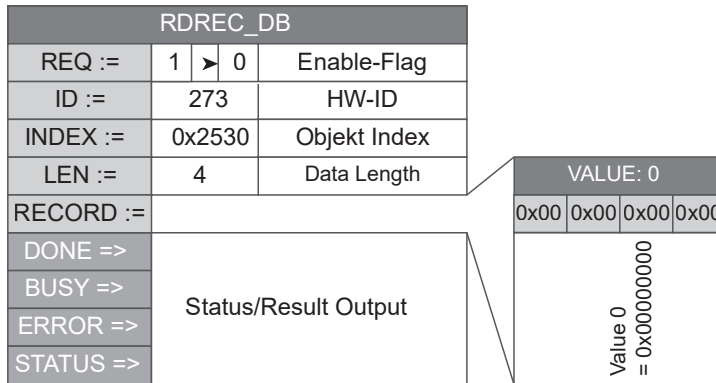

Fig. 55 SPS read command to turn off the laser light source on the sensor

8.8.2 Sequence When Writing Structured Data

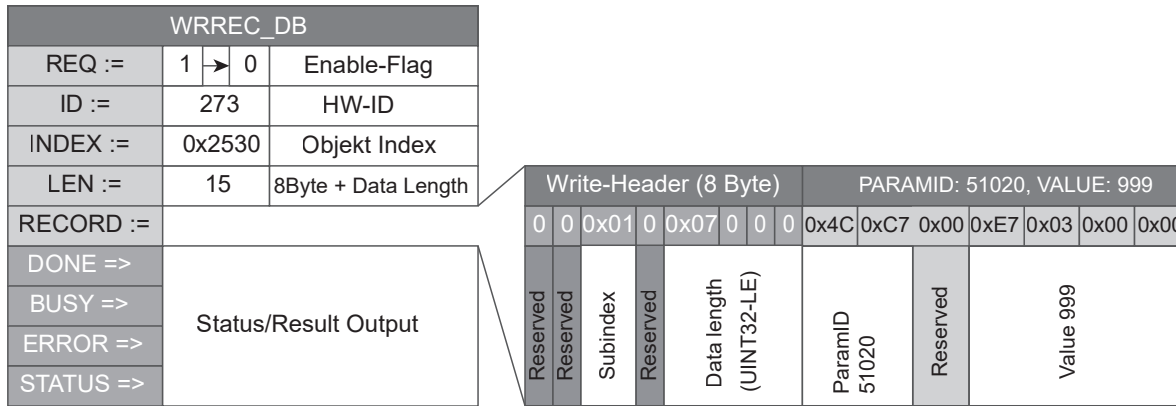

Fig. 56 Write command with data from PLC to sensor

9. Cleaning

We recommend cleaning the protective glass at regular intervals.

Dry Cleaning

This can be accomplished with an anti-static lens brush or by blowing off the windows with dehumidified, clean, oil-free compressed air.

Wet Cleaning

Use a clean, soft, lint-free cloth or lens cleaning paper and pure alcohol (isopropyl alcohol) to clean the protective glass pane.

Never use commercially available glass cleaner or other cleaning agents.

10. Disclaimer

All components of the device have been checked and tested for functionality in the factory. However, should any defects occur despite careful quality control, these shall be reported immediately to MICRO-EPSILON or to your distributor / retailer.

MICRO-EPSILON undertakes no liability whatsoever for damage, loss or costs caused by or related in any way to the product, in particular consequential damage, e.g., due to

- non-observance of these instructions/this manual,
- improper use or improper handling (in particular due to improper installation, commissioning, operation and maintenance) of the product,
- repairs or modifications by third parties,
- the use of force or other handling by unqualified persons.

This limitation of liability also applies to defects resulting from normal wear and tear (e.g., to wearing parts) and in the event of non-compliance with the specified maintenance intervals (if applicable).

MICRO-EPSILON is exclusively responsible for repairs. It is not permitted to make unauthorized structural and / or technical modifications or alterations to the product. In the interest of further development, MICRO-EPSILON reserves the right to modify the design.

In addition, the General Terms of Business of MICRO-EPSILON shall apply, which can be accessed under Legal details | Micro-Epsilon <https://www.micro-epsilon.com/impressum/>. For translations into other languages, the German version shall prevail.

11. Service, Repair

If the sensor or sensor cable is defective:

- If possible, save the current sensor settings in a parameter set, see Chap. 7.7.3, to reload them into the sensor after the repair.
- Please send us the affected parts for repair or exchange.

If the cause of a fault cannot be clearly identified, please send the entire measuring system to:

MICRO-EPSILON Optronic GmbH
Lessingstraße 14

01465 Langebrück / Germany

Tel. +49 (0) 35201 / 729-0

Fax +49 (0) 35201 / 729-90

optronic@micro-epsilon.com

www.micro-epsilon.com

12. Decommissioning, Disposal

In order to avoid the release of environmentally harmful substances and to ensure the reuse of valuable raw materials, we draw your attention to the following regulations and obligations:

- Remove all cables from the sensor and/or controller.
- Dispose of the sensor and/or the controller, its components and accessories, as well as the packaging materials in compliance with the applicable country-specific waste treatment and disposal regulations of the region of use.
- You are obliged to comply with all relevant national laws and regulations



For Germany / the EU, the following (disposal) instructions apply in particular:

- Waste equipment marked with a crossed garbage can must not be disposed of with normal industrial waste (e.g. residual waste can or the yellow recycling bin) and must be disposed of separately. This avoids hazards to the environment due to incorrect disposal and ensures proper recycling of the old appliances.
- A list of national laws and contacts in the EU member states can be found at https://ec.europa.eu/environment/topics/waste-and-recycling/waste-electrical-and-electronic-equipment-veee_en. Here you can inform yourself about the respective national collection and return points.
- Old devices can also be returned for disposal to MICRO-EPSILON at the address given in the imprint at <https://www.micro-epsilon.de/impressum/>.
- We would like to point out that you are responsible for deleting the measurement-specific and personal data on the old devices to be disposed of.
- Under the registration number WEEE-Reg.-Nr. DE28605721, we are registered at the foundation Elektro-Altgeräte Register, Nordostpark 72, 90411 Nuremberg, as a manufacturer of electrical and/or electronic equipment.



Appendix

A 1 Optional Accessories

<p>PS2020</p>		<p>Power supply for top-hat rail installation, input 230 VAC, output 24 VDC/2.5 A</p>
<p>PC1900-IE-x/RJ45</p>		<p>Interfaces and supply cable Length x = 3, 6 or 9 m 12-pin round socket and RJ45 plug for fieldbus connection</p>
<p>PC1900-IE-x/OE-RJ45</p>		<p>Power and output cable, Length x = 3, 6 or 9 m 12-pin round socket, RJ45 plug for fieldbus connection or open ends for supply and laser activation</p>

A 2 Factory Settings

Measurement averaging	Median, 9 values
Peak selection	Highest peak
Measuring range	100 % FSO: digital 163768 0 % FSO: digital 98232

Measuring rate	4 kHz
Language	German

Reset on factory setting does not change

- the IP address,
- the PROFINET name.

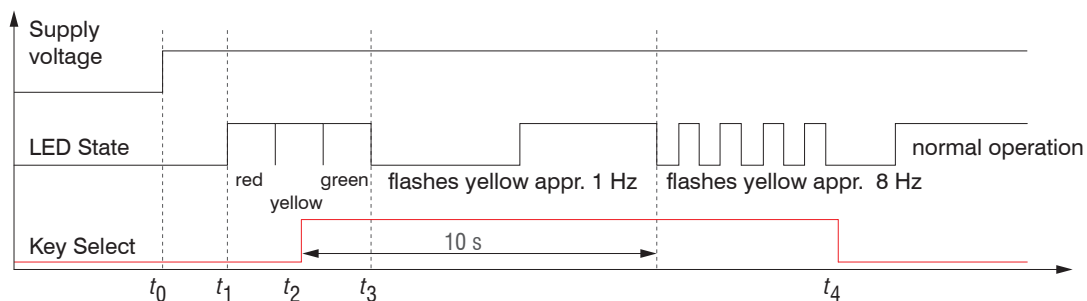

Fig. 57 Flowchart for starting a sensor with factory settings

t_0 : Supply voltage is applied

$t_1 \dots t_3$: both LEDs indicate the start sequence (red-yellow-green each for 1 sec.)

t_2 : Select button is pushed during the start sequence ($t_1 \dots t_3$)

t_4 : Select button is released while the State LED is flashing yellow

$\Delta t = t_4 - t_2$; Δt (key stroke duration) must be at least 10 sec., max. 15 sec.

Reset to factory setting: Press the `Select` button after having switched on the sensor while the two LEDs light up „red - yellow - green“. Hold the key pressed. After 10 seconds, the Status LED starts flashing quickly. If you release the key while it flashes quickly, the sensor is reset to factory settings. If you hold the key pressed for longer than 15 seconds, the sensor is not reset to factory settings. If the `Select` button is kept pressed when switching on the sensor (or with a reset), the sensor switches to the Bootloader mode.

A 3 Configuring the IP Address

Navigate to the properties of your PLC.

➡ To do this, click on the PLC in the `Network overview` or the `Device view`.

➡ Enter the correct IP address and subnet mask of your PLC in the `General > Ethernet addresses` tab.

The screenshot displays the SIMATIC Manager interface. The top window shows a network overview with two PLCs connected via a PROFINET IO system. The bottom window shows the 'Ethernet addresses' configuration for the selected PLC.

Network Overview:

Device	Type	Address in...
S7-1200-Station_1	S7-1200 station	
▶ PLC_1	CPU 1212C AC/DC/Rly	
▶ GSD device_1	GSD device	
▶ if2030pnet	IF2030/PNET	
▶ GSD device_2	GSD device	
▶ ild1900pnet	ILD1900/PNET	

Ethernet addresses configuration:

Interface networked with

Subnet: PN/IE_1

IP protocol

Set IP address in the project

IP address: 192 . 168 . 0 . 1

Subnet mask: 255 . 255 . 255 . 0

Use router

Router address: 0 . 0 . 0 . 0

If they do not know the IP address of their PLC, proceed as follows.

➡ Right click in the Network overview or in the Device overview on your PLC and select Online & diagnostics.

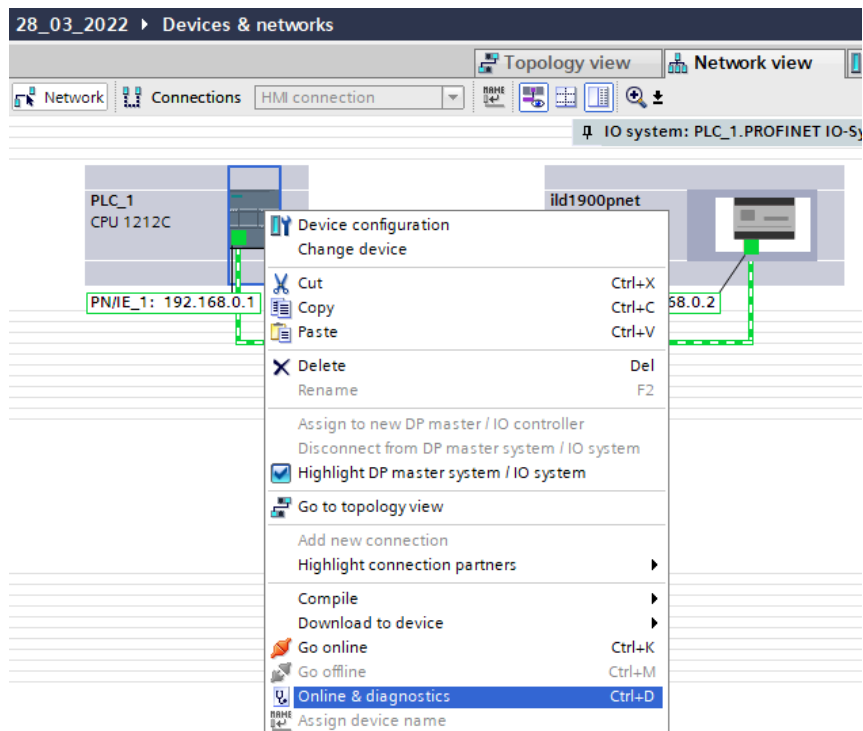

➡ Navigate to the **Functions > Assign IP address** section and click the **Accessible devices** button.

Online access

- ▶ Diagnostics
- ▼ Functions
 - Assign IP address**
 - Set time
 - Firmware update
 - Assign PROFINET device na...
 - Reset to factory settings
 - Format memory card

Assign IP address

Assign IP address to the device

⚠ Devices connected to an enterprise network or directly to the internet must be appropriately protected against unauthorized access, e.g. by use of firewalls and network segmentation. For more information about industrial security, please visit <http://www.siemens.com/industrialsecurity>

MAC address:

IP address:

Subnet mask:

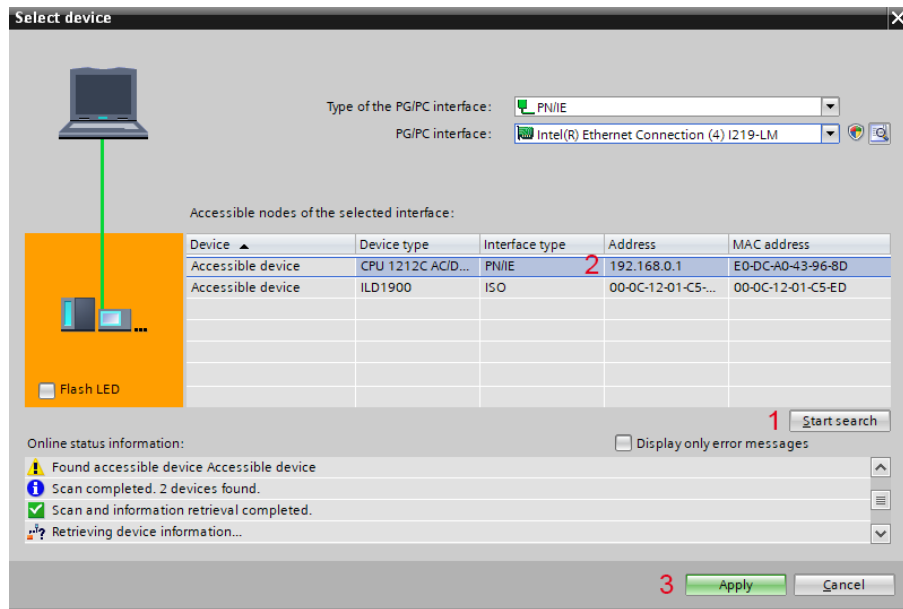

➔ Click the `Start search` button (1).

The list of accessible participants now shows you all participants with the corresponding IP addresses (2). Now that you know the IP address of your PLC, you can close the window by clicking `Cancel`.

➔ Click the `Apply` button (3) if you want to change the IP address of your PLC.

The MAC address of your PLC is now filled in and you can change the IP address of your PLC via the `Assign IP` address button. The IP address that you have previously specified in the properties of your PLC is assigned.

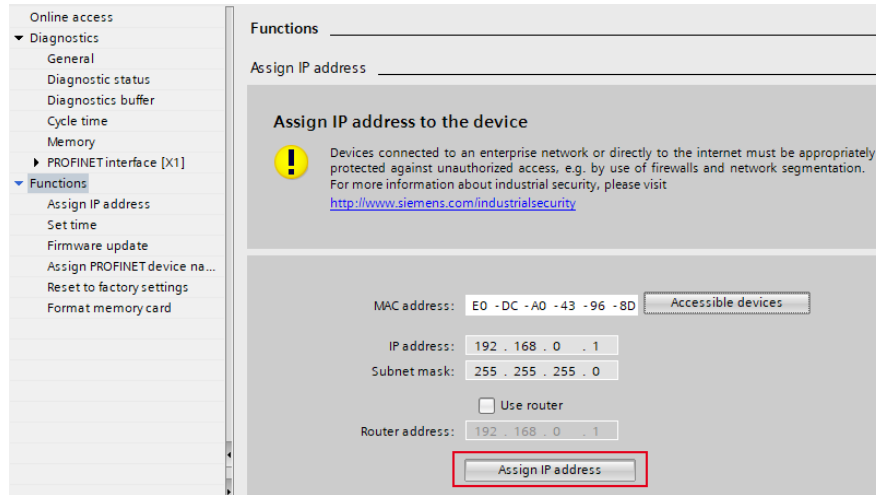

The screenshot displays the 'Functions' menu in the SIMATIC Manager software. The 'Assign IP address' option is selected, opening a dialog box titled 'Assign IP address to the device'. The dialog box features a warning icon and a message: 'Devices connected to an enterprise network or directly to the internet must be appropriately protected against unauthorized access, e.g. by use of firewalls and network segmentation. For more information about industrial security, please visit <http://www.siemens.com/industrialsecurity>'. Below the message, there are input fields for MAC address (E0 - DC - A0 - 43 - 96 - 8D), IP address (192 . 168 . 0 . 1), Subnet mask (255 . 255 . 255 . 0), and Router address (192 . 168 . 0 . 1). A checkbox labeled 'Use router' is currently unchecked. An 'Accessible devices' button is located next to the MAC address field. The 'Assign IP address' button at the bottom of the dialog is highlighted with a red rectangular box.

For the ILD1900-x-IE you can proceed accordingly with the assignment of the IP address.

➤ Click on the ILD1900-x-IE in the **Network overview** or in the **Device overview** to access the properties of the ILD1900-x-IE.

➤ Switch to the **Ethernet addresses** section and enter the correct IP address and subnet mask of the sensor.

The screenshot displays the SIMATIC Manager interface for configuring an ILD1900-x-IE sensor. The main window shows the 'Device overview' table, which lists the device and its modules. The 'Properties' window is open to the 'Ethernet addresses' section, where the IP address and subnet mask are configured.

Module	Rack	Slot	I address	Q address	Type
ild1900pnet	0	0			ILD1900/PNET
PN-IO	0	0 X1			ild1900pnet
Oversampling 1 Input_1	0	1			Oversampling 1 ...
	0	11			
	0	12			
	0	13			
	0	14			
	0	15			
	0	16			
	0	2			
	0	3			
	0	4			
	0	5			

The 'Properties' window is open to the 'Ethernet addresses' section. The 'Interface networked with' dropdown is set to 'PN/IE_1'. The 'IP protocol' section shows the following configuration:

IP address: 192 . 168 . 0 . 2
 Subnet mask: 255 . 255 . 255 . 0
 Synchronize router settings with IO controller
 Use router
 Router address: 0 . 0 . 0 . 0

If you do not know the IP address of the sensor or if the ILD1900-x-IE does not yet have an IP address when delivered, proceed as follows.

▶ Right click on your sensor in the Network overview or in the Device overview and select Online & diagnostics.

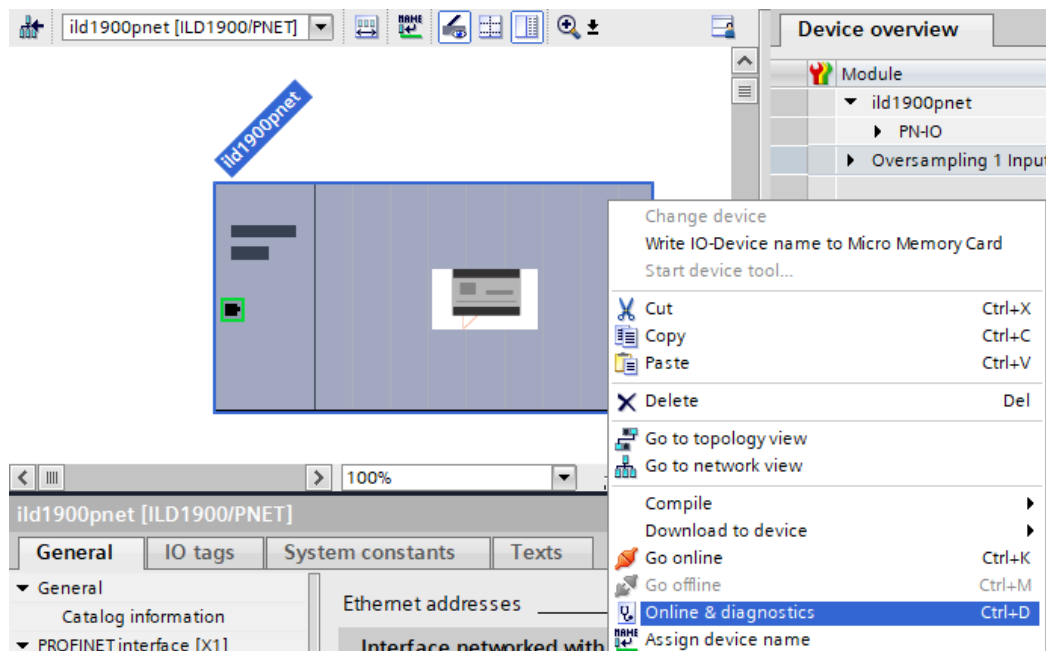

➔ Navigate to the **Functions > Assign IP address** section and click the **Accessible devices** button.

Assign IP address

Assign IP address to the device

 Devices connected to an enterprise network or directly to the internet must be appropriately protected against unauthorized access, e.g. by use of firewalls and network segmentation. For more information about industrial security, please visit <http://www.siemens.com/industrialsecurity>

MAC address:

IP address:

Subnet mask:

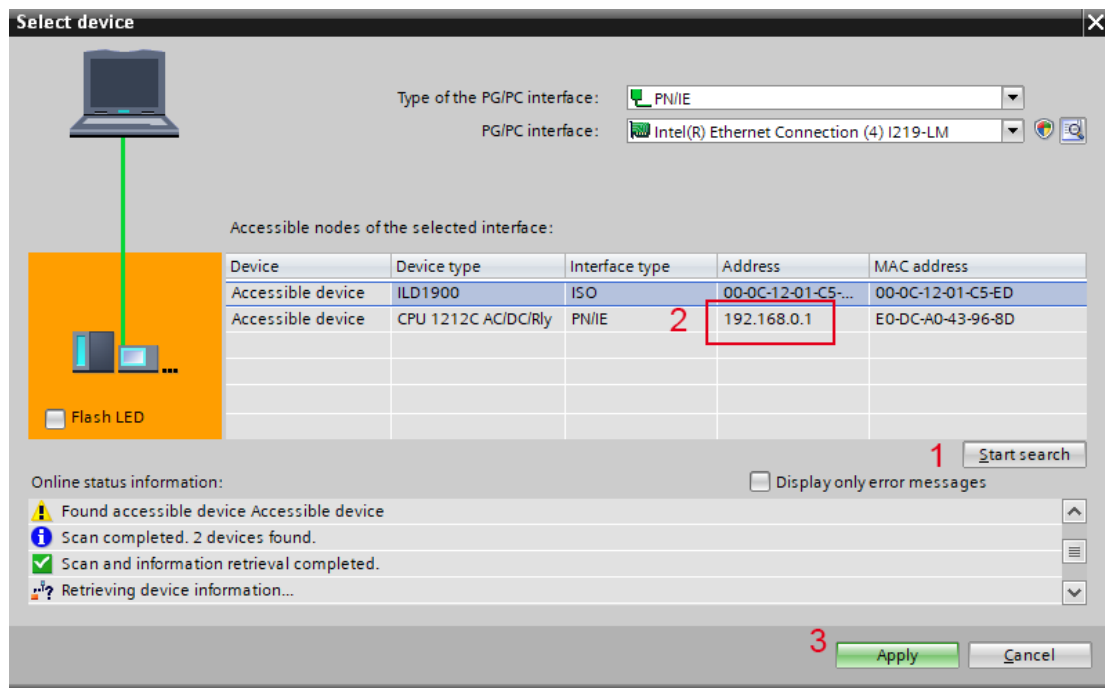

➔ Click the `Start search` button (1).

The list of accessible participants now shows you all participants with the corresponding IP addresses (2). Now that you know the IP address of your sensor, you can close the window by clicking `Cancel`.

➔ Click the `Apply` button (3) if you want to change the IP address of the ILD1900-x-IE or assign it for the first time.

The MAC address of the sensor is now filled in and you can change the IP address of your sensor via the `Assign IP address` button. The IP address that you have previously specified in the properties of your sensor will be assigned.

Assign IP address

Assign IP address to the device

 Devices connected to an enterprise network or directly to the internet must be appropriately protected against unauthorized access, e.g. by use of firewalls and network segmentation. For more information about industrial security, please visit <http://www.siemens.com/industrialsecurity>

MAC address: 00 - 0C - 12 - 01 - C5 - ED

IP address: 192 . 168 . 0 . 2

Subnet mask: 255 . 255 . 255 . 0

Use router

Router address: 192 . 168 . 0 . 2

The IP address of the sensor is stored retentively in the sensor.

A 4 PROFINET Parameter List

Name	Parameter ID	Data type	Value range	Description	Access
Light source					
Laser power	50500	UINT8	0 - Off 1 - Full 2 - Reduced	Switch laser on and off	rw
Measurement Configuration, Measuring Rate, Evaluation Range (ROI), Exposure, Peak Selection, Error Handling					
Measurement task	51000	UINT8	0 - Standard 1 - Multisurface 2 - Penetration	Measurement task, object properties	rw
Measuring rate	51002	FLOAT		Free measuring rate; 250 ... 10000 Hz	rw
Start of range (ROI)	51009	UINT16		Start of evaluation range	rw
End of range (ROI)	51010	UINT16		End of evaluation range	rw
Shutter mode	51019	UINT8	0 - Manual 1 - Automatic	Exposure mode, automatic or manual	rw
Shutter value in μs	51020	FLOAT		Exposure time for manual mode; 1 ... 4000 μs	rw
Exposure mode	51021	UINT8	0 - Standard 1 - Intelligent 2 - Background	Selection for automatic exposure	rw
Peak selection	51029	UINT8	0 - Highest peak 1 - Widest peak 2 - Last peak 3 - First peak	Peak selection video signal for distance calculation	rw
Error handling type	51039	UINT8	0 - None 1 - Value 2 - Infinite	Behavior of digital output in case of error	rw
Error handling values	51040	UINT32	1 ... 1024	Hold value for number of measuring cycles	rw

Name	Parameter ID	Data type	Value range		Description	Access
Averaging						
Comp1 type	52000	UINT8	0 - None 1 - Median	2 - Moving 3 - Recursive	Averaging type	rw
Average 1 number of values for moving average	52001	UINT32	2 - 2 4 - 4 8 - 8	... 2048 - 2048 4096 - 4096	Number of values over which the average is taken	rw
Average 1 number of values for median	52002	UINT32	3 - 3 5 - 5	7 - 7 9 - 9		rw
Average 1 number of values for recursive	52003	UINT32	2 - 2 3 - 3 4 - 4	5 - 5 ... 32000 - 32000		rw
Comp2 type	52010	UINT8	0 - None 1 - Median	2 - Moving 3 - Recursive	Averaging type	rw
Average 2 number of values for moving average	52011	UINT32	2 - 2 4 - 4 8 - 8	... 2048 - 2048 4096 - 4096	Number of values over which the average is taken	rw
Average 2 number of values for median	52012	UINT32	3 - 3 5 - 5	7 - 7 9 - 9		rw
Average 2 number of values for recursive	52013	UINT32	2 - 2 3 - 3 4 - 4	5 - 5 ... 32000 - 32000		rw
Zeroing, Mastering						
Master enable	53001	BOOL	0 - False 1 - True	Determine signal DIST1 for zeroing/mastering		rw
Master set	53003	BOOL	0 - False 1 - True	Perform or end zeroing or mastering		rw
Master value	53004	FLOAT		Specify the thickness (or other parameter) of a master object. Value range -2 to +2 x measuring range		rw

Name	Parameter ID	Data type	Value range	Description	Access
System Setting, Key Lock, Login, Password, Factory Setting					
Key lock	54000	UINT8	0 - None 1 - Active 2 - Auto	Key lock Select button	rw
Key lock time	54001	UINT8	1 ... 60 min	For Auto function : key lock starts after expiration;	rw
Current user	54010	UINT8	1 - User 3 - Professional	User level query	ro
Login	54011	STRING(32)		Password for a change to the Professional level	wo
Logout	54012	BOOL	0 - No 1 - Yes	Change to User level	rw
Default user	54013	UINT8	0 - User 1 - Professional	Setting the user level after a restart of the sensor	rw
Old password	54014	STRING(32)		Create and change password for the Professional level	wo
New password	54015	STRING(32)			wo
Repeat password	54016	STRING(32)			wo
Reset to factory measurement settings	54020	BOOL	0 - False 1 - True	Reset measurement settings	wo
Reset to factory device settings	54021	BOOL	0 - False 1 - True	Reset device settings	wo
Reset to factory all settings	54023	BOOL	0 - False 1 - True	Reset all	wo
Reboot sensor	54024	BOOL	0 - False 1 - True	Reboot sensor	wo

Name	Parameter ID	Data type	Value range	Description	Access
Load, Save Device Settings					
Load	54500	BOOL	0 - False 1 - True	Loads the saved device settings from the sensor	wo
Save	54501	BOOL	0 - False 1 - True	Saves the current device settings in the sensor	wo
Load and Apply Presets					
Mode	55000	UINT8	0 - None 1 - Static (Statisch) 2 - Balanced (Ausgewogen) 3 - Dynamic (Dynamisch) 4 - No averaging (Ohne)	Returns the currently used preset mode (signal quality); with <Parameter> the preset mode (signal quality) to be used is set.	rw
List	55001	STRING(230)		Lists all existing manufacturer-specific programs.	ro
Read	55002	STRING(32)		Loads and executes a preset <Name> for use in the sensor.	wo

Name	Parameter ID	Data type	Value range	Description	Access
Load, Save and Apply Setups					
Current	55500	STRING(32)		Returns the name of the currently used preset or setup.	ro
Read	55501	STRING(32)		Loads and executes a setup <Name> for use in the sensor.	wo
Store	55502	STRING(32)		Saves the current user-specific settings to a Setup <Name> or a new Setup <Name> is created in non-volatile memory.	wo
Delete	55503	STRING(32)		Deletes the associated setup <Name>	wo
Initial	55504	STRING(32)		Returns the name of the setup intended for the next start of the sensor. With <Name> a setup is determined, which will be used at the next start of the sensor. Presets cannot be indicated.	rw
List	55505	STRING(32)		Returns the names of all saved setups.	ro
Sensor Information					
Measuring range	56000	FLOAT		Returns the measuring range of the sensor	ro
Option	56001	STRING(32)		Contains the option number of the sensor	ro



MICRO-EPSILON MESSTECHNIK GmbH & Co. KG

Königbacher Str. 15 · 94496 Ortenburg/Germany

Phone +49 8542 / 168 0 · Fax +49 8542 / 168 90

info@micro-epsilon.com · www.micro-epsilon.com

Your local contact: www.micro-epsilon.com/contact/worldwide/

X9751444.02-A022013MSC

© MICRO-EPSILON MESSTECHNIK