



## Assembly Instructions

### scanCONTROL 3000 / 3002

#### 1. Warnings

Connect the power supply and the display-/output device according to the safety regulations for electrical equipment. The supply voltage must not exceed the specified limits.

> Risk of injury, damage to or destruction of the sensor

Avoid shocks and impacts to the sensor. Avoid constant exposure of the sensor to dust and splashes of water. Avoid exposure of sensor to aggressive materials (detergents, cooling emulsions).

> Damage to or destruction of the sensor

You can find more information about the sensor in the operating instructions. They are online at:

[www.micro-epsilon.com/download/manuals/man--scanCONTROL-30xx--en.pdf](http://www.micro-epsilon.com/download/manuals/man--scanCONTROL-30xx--en.pdf)

#### 2. Notes on Product Marking

The product meets the requirements of CE and UKCA. All specifications and safety instructions described in the operating instructions must be observed.

#### 3. Proper Environment

- Protection class: IP67
- Temperature range:
  - Operation: 0 ... +45 °C (+32 ... +113 °F), for free circulation of air
  - Storage: -20 ... +70 °C (-4 ... +158 °F)
- Humidity: 5 ... 95 % (non-condensing)

## 4. Laser Safety

The scanCONTROL 30xx sensors operate with a semiconductor laser with a wavelength of 658 nm resp. 660 nm (visible/red). Operation of the laser is indicated visually by the LED on the sensor, see operating instructions Chap. 3. When operating the scanCONTROL 30xx sensors, the relevant regulations according to IEC 60825, Part 1 and the applicable accident prevention regulations must be followed. The laser warning labels for Germany have already been attached. For other non German speaking countries, an IEC standard label is included in delivery and the versions valid for the user's country must be attached before the device is put into operation for the first time.

**i** If both warning labels are covered over when the unit is installed, the user must ensure that supplementary labels are applied.

### Laser Class 2M



Laser radiation. Irritation or injury of the eyes possible. Close your eyes or immediately turn away if the laser beam hits the eye.

The sensors fall within laser class 2M (IIM). The laser is operated on a pulsed mode, the maximum optical power is  $\leq 10$  mW,  $\leq 12$  mW resp.  $\leq 26$  mW. Attach the following warning labels to the cover of the sensor housing.

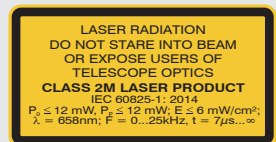
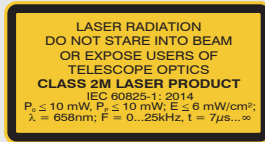

Fig. 1 LLT30xx-25, LLT30xx-50, LLT30xx-100 Fig. 2 LLT30xx-200

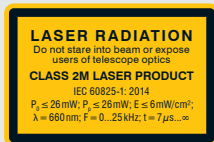

Fig. 3 LLT30xx-430, LLT30xx-600



Only for USA

**i** Mark the laser area recognizable and everlasting.



Fig. 4 Sensor LLT30xx-25, LLT30xx-50, LLT30xx-100, LLT30xx-200 with laser labels

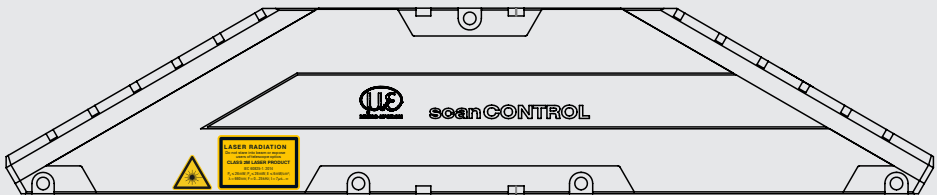

Fig. 5 Sensor LLT30xx-430, LLT30xx-600 with laser labels

### Laser Class 3R



Laser radiation. Irritation or injury of the eyes possible. Use suitable protective equipment and close your eyes or immediately turn away if the laser beam hits the eye.

The sensors with the /3R option fall within laser class 3R. The laser is operated on a pulsed mode, the maximum optical power is  $\leq 30$  mW,  $\leq 50$  mW resp.  $\leq 100$  mW. Attach the following warning labels to the cover of the sensor housing.



Fig. 6 LLT30xx-25, LLT30xx-50

Fig. 7 LLT30xx-100, LLT30xx-200

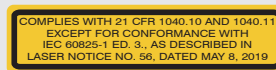

Only for USA

Fig. 8 LLT30xx-430, LLT30xx-600

i Mark the laser area recognizable and everlasting.

In addition, the following information label must be attached to the laser output on the sensor housing:

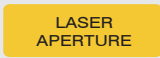

Fig. 9 LLT30xx-25, LLT30xx-50, LLT30xx-100, LLT30xx-200

Fig. 10 LLT30xx-430, LLT30xx-600

i Class 3R laser sensors require a laser protection officer.

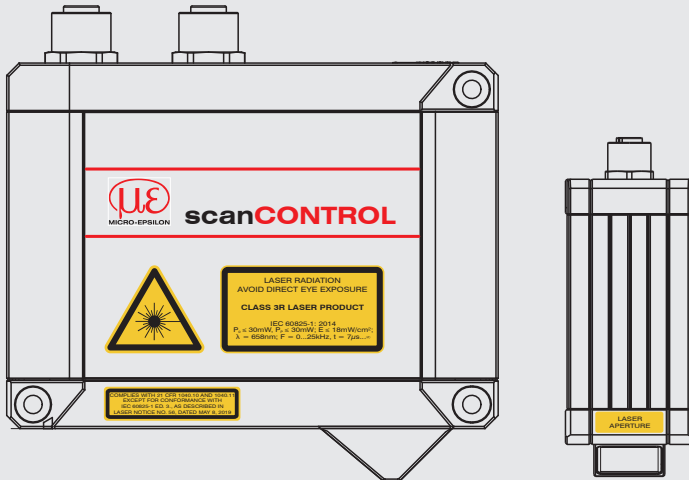

Fig. 11 Sensor LLT30xx-25, LLT30xx-50, LLT30xx-100, LLT30xx-200 with laser labels

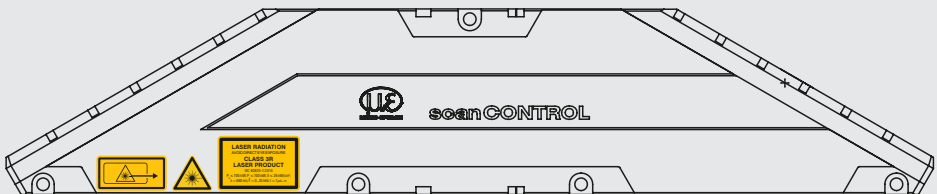

Fig. 12 Sensor LLT30xx-430, LLT30xx-600 with laser labels

## 5. Connections, LED Displays



- 1 Multifunction port (power supply, I/O)
- 2 Ethernet port

### Multifunction Port

Designation	Sensor connector pin	Cable color PCR3000-x	Notes
V <sub>+</sub>	9	Red	+ 11 V - 30 V DC (rated value 24 V); max. 5 W
GND	2	Blue	0 V
+Laser on/off	3	White	Available with SI option
-Laser on/off	1	Brown	
RS422	12	Red-blue	RS422 input or output
/RS422	11	Gray-pink	
GND RS422	10	Purple	Ground connection RS422
In1	4	Green	Switching input In1
In2	6	Yellow	Switching input In2
In3	8	Gray	Switching input In3
In4	5	Pink	Switching input In4
GND-In	7	Black	Ground connection In
Shield	Housing	Black	Not electrically connected to GND

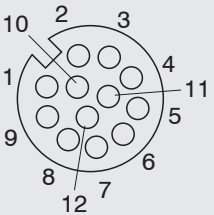

GND: galvanically isolated from In1, In2, In3, In4, RS422, laser on/off

Laser on/off: input galvanically isolated from GND, In1, In2, In3, In4, RS422

In1, In2, In3, In4, RS422: inputs galvanically isolated from GND and laser on/off

12-pin screw connector, view on solder side (cable)

## RS422, Synchronization

The RS422 connection (pins 11 and 12 of the multifunction port) can be used in either of the following configurations:

- RS422 (half-duplex): Load user modes, sensor control and transmit measurement results (Modbus RTU or ASCII format).
- Synchronization/triggering: Synchronization or triggering using switching signals.

## Trigger, Encoder, Mode Switching

The switching inputs of the multifunction port can either be used for encoder input, trigger input or for load previously stored user modes.

The signal levels are switchable for all switching inputs between LLL (TTL logic) and HLL (HTL logic):

- LLL level: Low 0 V ... 0.8 V, high 2.4 V ... 5 V, internal pull-up/down switchable resistor 10 k $\Omega$
- HLL level: Low 0 V ... 3 V, high 11 V ... 24 V (permitted to 30 V), internal pull-up/down switchable resistor 10 k $\Omega$
- Pulse duration:  $\geq 5 \mu\text{s}$

## External Laser Switch-off, Optional

Externally switching off the laser is implemented as a hardware solution and is a top priority. The laser can also be switched off by software.

This function is offered by sensors with the /SI option.

 Use a serial key switch in the control circuit to switch off the laser.

With standard sensors, connecting the supply voltage activates the laser light source in the sensor.

Wiring details are available in the operating instructions, Chap. 5.

## Ethernet Connection, Standard Connection to PC

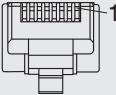
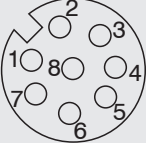
RJ45 connector		8-pin screw connector (sensor side)		
Pin no.	Color of stranded hook-up wire SCR3000A-x	Pin no.	10BaseT, 100BaseTX	1000BaseT
1	White (orange)	5	Tx+	D1+
2	Orange	6	Tx-	D1-
3	White (green)	8	Rx+	D2+
4	Blue	1		D3+
5	White (blue)	2		D3-
6	Green	7	Rx-	D2-
7	White (brown)	3		D4+
8	Brown	4		D4-
 <p>View on pin side of male cable connector</p>		 <p>View on solder side (cable) of screw connector (A-coded)</p>		

- The sensor supports an automatic, sensor-specific IP address in the link-local net (169.254.x.x). No collision detection is implemented. This is also the default setting.
- The sensor supports DHCP. This setting is activated by default and has priority over search the link-local net.
- The sensor scanCONTROL 30xx supports Power over Ethernet.

### NOTICE

If the sensor is connected to a POE-capable network adapter/switch and you also use the power supply of the multifunction port, these two power supplies must be galvanically isolated.  
 > Damage to the sensor and/or Ethernet card!

- A fixed IP address can be assigned.

➡ Use the `sensorTOOL` program to make specify the sensor settings described above.

The program is available online at <https://www.micro-epsilon.com/download/software/sensorTOOL.exe>.

## LED Displays

	<b>LED Laser</b>	<b>LED Data</b>	<b>LED Error</b>
	Yellow: Laser on	Green: Measurement is active  Green, flashes: Data transmission is active	Red, flashes: Error code, see operating instructions Chap. 12
	The Data LED flashes green, long during active transmission and short for controller accesses.		

## 6. System Requirements

### scanCONTROL Configuration Tools

The following minimum system requirements are necessary:

- Windows 8 or 8.1, Windows 10, Windows 11 (64 bit each)
- 1-GHz processor (64 bit)
- 1 GB RAM
- Screen resolution: 1024 x 768

### scanCONTROL 3D-View

The following minimum system requirements are necessary:

- Windows 8 or 8.1, Windows 10, Windows 11 (64 bit each)
- 1-GHz or faster (64 bit) processor or higher
- 1 GB RAM
- Screen resolution: 1024 x 768
- Graphics card / GPU with OpenGL 3.1 or higher



## 7. Quick Start, Initial Operation, Software

- ➔ Mount the sensor according to the installation instructions.
- ➔ Install the software.

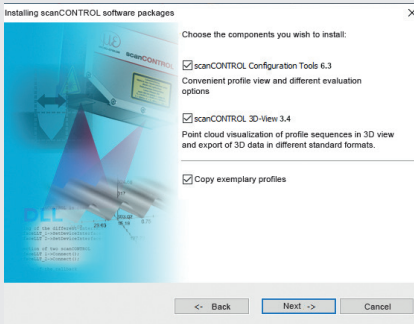

You will find the software online on the product website of the sensor or in the download area:

[https://www.micro-epsilon.com/2D\\_3D/laser-scanner/Software/downloads/](https://www.micro-epsilon.com/2D_3D/laser-scanner/Software/downloads/).



Follow the dialog through the installation process:

- A. Reading the installation help
- B. Installing the software
- C. Additional information in the online documentation

- ➔ Connect the sensor to the PC using the optionally available SCR3000A-x Ethernet cable.
- ➔ Connect the shield of the power supply cable to the PE grounding conductor of the main power supply. Close unused connection plugs with the included protective caps. Turn on the power supply (24 VDC).
- ➔ Please wait until the scanCONTROL measuring system is recognized by the PC. This may take a few seconds.
- ➔ Now you can operate the scanCONTROL measuring system with the scanCONTROL software packages.

**i** Operating a scanCONTROL sensor via Ethernet may require the IP settings of the PC/sensor or the firewall settings to be adjusted, see Chap. 5.2.5 of the operating instructions.

The connectors for Ethernet and the multifunction port include a screw connector. Loosen the screws connection before you remove the connector from the socket.

**i** Only connect the sensor to the peripheral equipment, if it is disconnected from the power supply, i.e. only when the operating voltage is switched off. The sensor needs a warm-up time of typically 20 minutes for high precision measurements.

## 8. First Profile

▶ Now start the scanCONTROL Configuration Tools software. Click on **Display Profiles** in the main window.

If the software shows the error message **No scanCONTROL found** in the status line, please check the Ethernet connection between scanCONTROL and the PC.

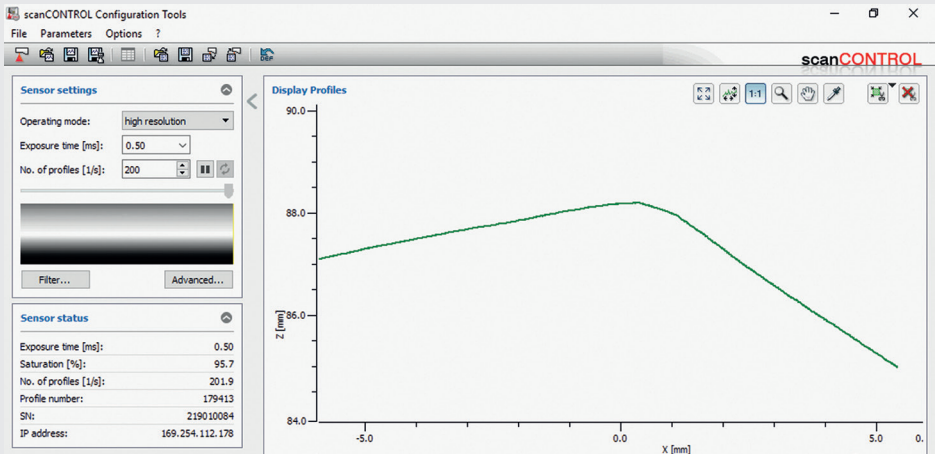

On the left side you can adjust the settings for your measurement task, the right side shows the profile data and information about the measurement.

## 9. How to Access Profile Data

Profile data of scanCONTROL can be accessed via:

- GigEVision and GenICam for digital cameras via Ethernet interface
- SDK for fast application integration (C, C++, C# and others)

Please refer to the respective SDK documentation for further information on accessing the profile data.

## 10. Unpacking, Included in Delivery

- 1 scanCONTROL 30xx sensor with integrated controller
- 1 PCR3000-5 multifunction cable, length 5 m; for power supply, trigger and RS422; screw connector and free cable ends
- Calibration final inspection / assembly instructions
- 2 Protective caps
- Centering elements (MB25-200: 2 pcs. / MB430/600: 4 pcs.)
- IEC warning labels

## 11. Additional Information

Please refer to

- the enclosed online documentation
- the “Status and Error Messages“ and “Notes“ sections in the scanCONTROL Configuration Tools operating instructions.

You will find details about the individual programs in the respective operating instructions or in the operating instructions of this sensor, Chap. 6.2.

You will find the operating instructions online at [www.micro-epsilon.com](http://www.micro-epsilon.com).

[www.micro-epsilon.com](http://www.micro-epsilon.com)

MICRO-EPSILON Messtechnik GmbH & Co. KG

Koenigbacher Str. 15

94496 Ortenburg / Germany, Tel. +49 (0) 85 42/1 68-0

Your local contact: [www.micro-epsilon.com/contact/worldwide/](http://www.micro-epsilon.com/contact/worldwide/)



X9771399.05-A032103HDR