

Proper Environment

- Protection class: IP 65 (only with sensor cable connected)

Lenses are excluded from protection class. Contamination of the lenses leads to impairment or failure of the function.

- Operating temperature: 0 ... 50 °C (+32 up to +122 °F)
- Storage temperature: -20 ... 70 °C (-4 up to +158 °F)
- Humidity: 5 - 95 % (no condensation)
- Ambient pressure: Atmospheric pressure

Dimensional Drawing and Free Space,

Measuring Ranges 2/10/20/50/100/200/250VT mm

Measuring Ranges 20/200BL

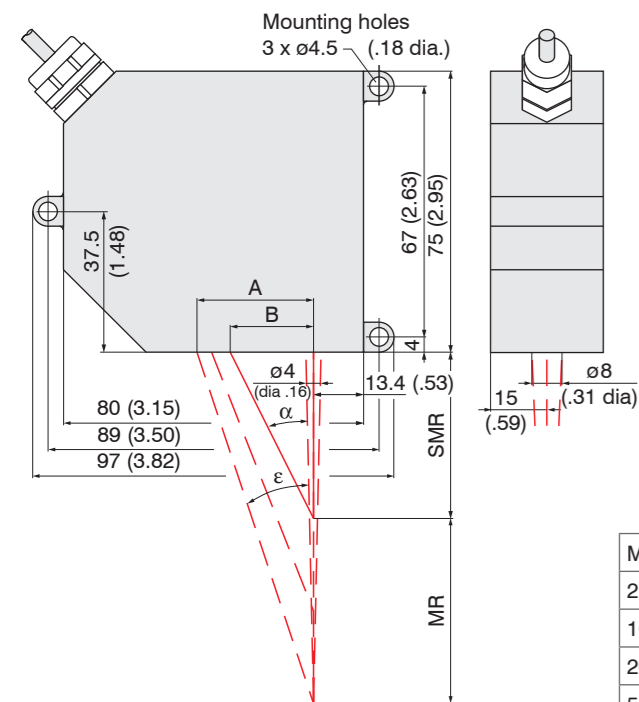
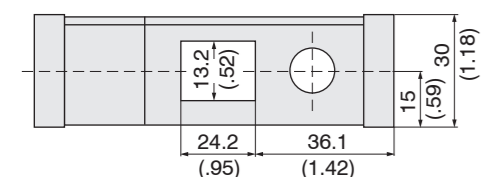

Sensor Mounting

The sensors of the series optoNCDT 1700 are optical sensors with which is measured in the μm area.

i Make sure that mounting and operation is handled carefully!

➔ Mount the sensors with three screws type M4. The bearing surfaces surrounding the fastening holes (through holes) are slightly raised.



MR	SMR	α	ϵ	A	B
2	24	35.0°	44.8°	25.8	16.8
10	30	34.3°	35.6°	28.7	20.5
20	40	28.8°	26.7°	30.1	22.0
50	45	26.5°	18.3°	31.5	22.5
100	70	19.0°	10.9°	32.6	24.1
200	70	19.0°	7.0°	33.1	24.1
250VT	70	19.0°	6.0°	33.5	24.1
20BL	40	28.8°	26.7°	30.1	22.0
200BL	100	13.5°	6.3°	33.1	24.1

Dimensions in mm (inches), not to scale

MR = Measuring range

SMR = Start of measuring range

MMR = Midrange

EMR = End of measuring range

Membrane Keys, LED's

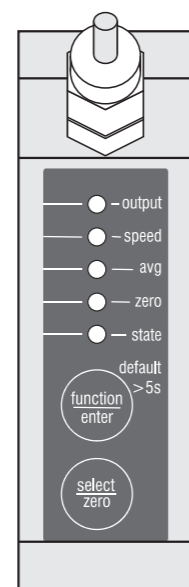

Measurement mode (normal operation):

- zero key:
 - Sets the analog output to the value for the midrange, i.e. 5 VDC or 12 mA.
 - Pressing the zero key again resets the function.
- function key:
 - Switches the sensor to setup mode.

Pressing and holding the function/enter key for longer than 5 seconds, overwrites all the parameter values with the factory settings (default values).

Setup mode (function key actuated):

- function key:
 - For running through the levels and parameters.
- select key:
 - To open the selection list and
 - select the value of the parameter in sequence.
- enter key:
 - For saving the selected parameter value and
 - returning to measurement mode.

If approximately 15 seconds have elapsed since the last press of the function key or 30 seconds since the last press of the select key, the sensor returns to measurement mode without changing the parameters.

LED	Status	Measurement mode	Setup mode
	illuminated	Object is in the measurement range or error	...
state	off	Sensor off or laser off	
	flashes slowly	...	Selected parameter value matches the saved value
	flashes quickly	...	Selected parameter value does not match the saved value
output speed	illuminated or flashing	Indication of the parameter values level 1	Selected parameter value
	flashing red		Status „off“
	illuminated	Sensor „master“ or „set to mid-point“	
zero	off	Normal operation	
	flashing	Sensor as slave without synchronous signal	

In case of bore holes, blind holes and edges in the surface of moving targets the sensor must be arranged in such a way that the edges do not obscure the laser spot.

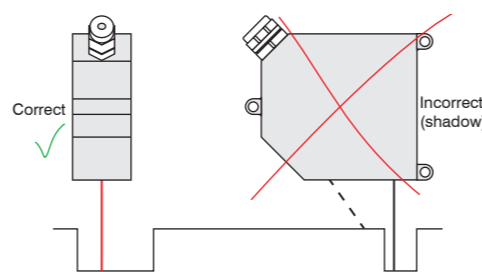

Inputs and Outputs

Pin	Designation	Comment	Sensor cable PC1700-x
5	+U _B	Power supply (11 ... 30 VDC)	red
6	GND	System ground for power supply and switching signals (Laser on/off, Zero, Limits)	black
13	Analog output	Current 4 ... 20 mA or voltage 0 ... 10 V	Coaxial inner conductor, white
14	AGND	Reference potential for analog output	Coaxial screening
9	Laser on/off	Switching input laser on /off	red-blue
10	Zero	Switching input setting mid-point	white-green
8	Switching output 1	Error or limit output	gray-pink
7	Switching output 2	Limit output	violet
3	Sync + ¹	Symmetrical synchron output (Master) or input (Slave)	blue
4	Sync - ¹		pink
1	Tx +	RS422 - output (symmetrical)	green
2	Tx -		brown
12	Rx +	RS422 - input (symmetrical)	gray
11	Rx -		yellow

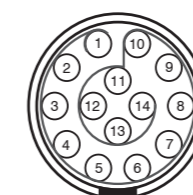

1) Used as trigger inputs in mode „Triggering“.

Plug connector: ODU MINI-SNAP, 14-pin, series B, dimension 2, code 0, IP 68; www.odu.de

View on solder-pin side male cable connector, insulator

Power Supply, nominal value: 24 VDC (11 ... 30 V, max. 150 mA).

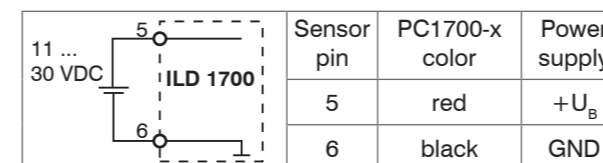

Sensor pin	PC1700-x color	Power supply
5	red	+U _B
6	black	GND

Use power supply only for measurement devices. MICRO-EPSILON recommends the use of the optional available power supply PS2020 for the sensor.

Switching Inputs Laser On/Off, Setting Masters and Mid-point

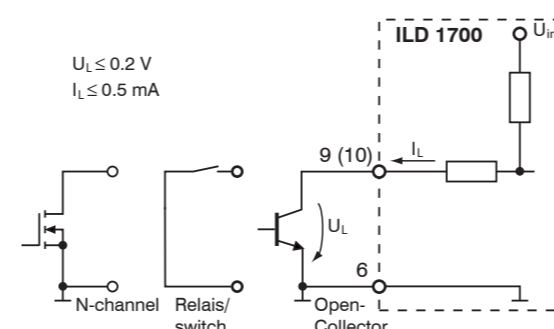

The switching inputs for laser on/off and setting masters/mid-point are similarly wired. Connect pin 9 with pin 6 in order to activate the laser. If the connection is released, the laser is deactivated.

MICRO-EPSILON MESSTECHNIK GmbH & Co. KG
Koenigbacher Str. 15 · 94496 Ortenburg
www.micro-epsilon.com



X9771139-A081129SWE



Assembly Instructions optoNCDT 1700

ILD 1700-2/10/20/50/100/200/250VT

ILD1700-2/10/20/50LL

ILD 1700-20/200BL

Proper Use

The optoNCDT1700 is designed for use in industrial areas. It is used for measuring displacement, distance, position and elongation for in-process quality control and dimensional testing.

The sensor may only be operated within the limits specified in the technical data, see instruction manual, Chap. 3.4. The sensor should only be used in such a way that in case of malfunctions or failure personnel or machinery are not endangered. Additional precautions for safety and damage prevention must be taken for safety-related applications.

Warnings

Connect the power supply in accordance to the safety regulations for electrical equipment. The power supply may not exceed the specified limits.
> Danger of injury, damage to or destruction of the sensor

Avoid continuous exposure to spray on the sensor. Avoid exposure to aggressive materials (washing agent, penetrating liquids or similar) on the sensor. Mount the sensor only to the existing holes on a flat surface. Clamps of any kind are not permitted.
> Damage to or destruction of the sensor

Avoid shock and vibration to the sensor. Protect sensor cable against damage.
> Damage to or destruction of the system, failure of the measuring device

Laser Class

The optoNCDT1700 sensors operate with a semiconductor laser with a wavelength of 670 nm (visible/red, ILD 1700) respectively 405 nm (visible/blue, ILD 1700BL).

The following warning labels are attached to the cover (front and/or rear side) of the sensor housing:

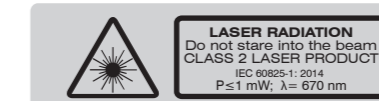

IEC label

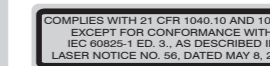

Only for USA

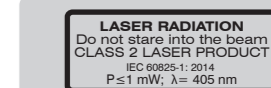

IEC label for ILD1700-x BL only



Never deliberately look into the laser beam! Consciously close your eyes or turn away immediately if ever the laser beam should hit your eyes.

Quick Guide

Components, Typical Application with Analog Output

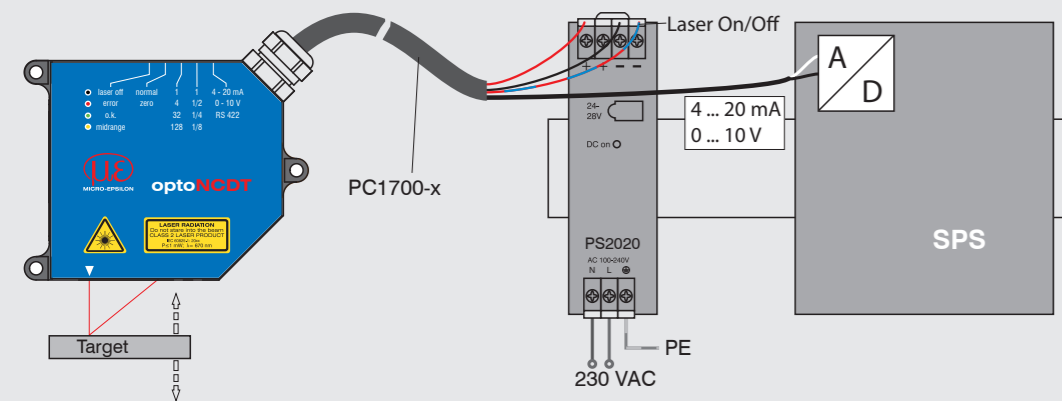

Components, Typical Application with RS422 and IF2008

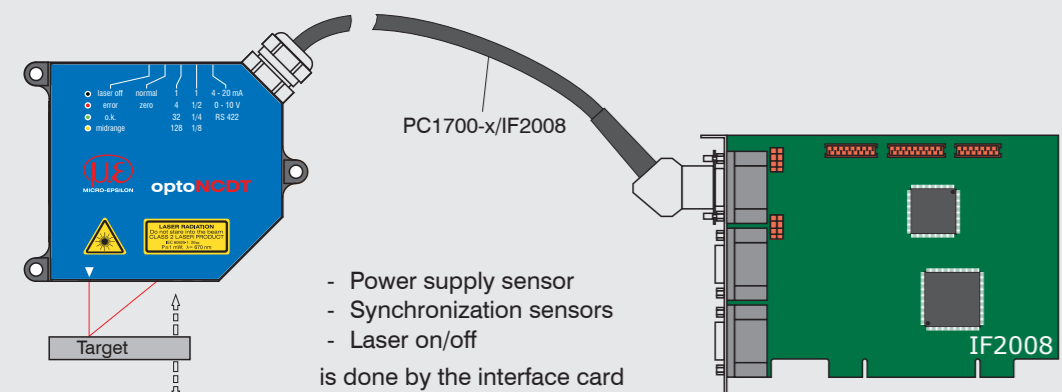

Switching on the Power Supply Respectively PC

➡ Switch on power supply respectively PC after completion of wiring.

The initialization including the info string transmission takes up to 10 seconds. Within this period, the sensor neither executes nor replies commands. To be able to produce reproducible measurements the sensor typically requires a start-up time of 20 minutes.

Change Measurement Value Output

➡ Change the output type with the `function/enter` and `select/zero` keys.

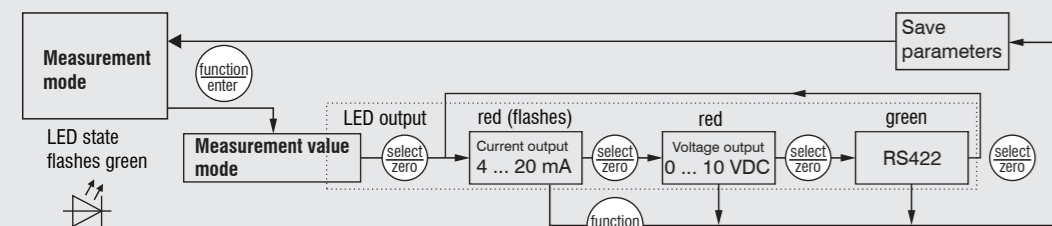

Place Target

➡ Place the target in the midrange, if possible.

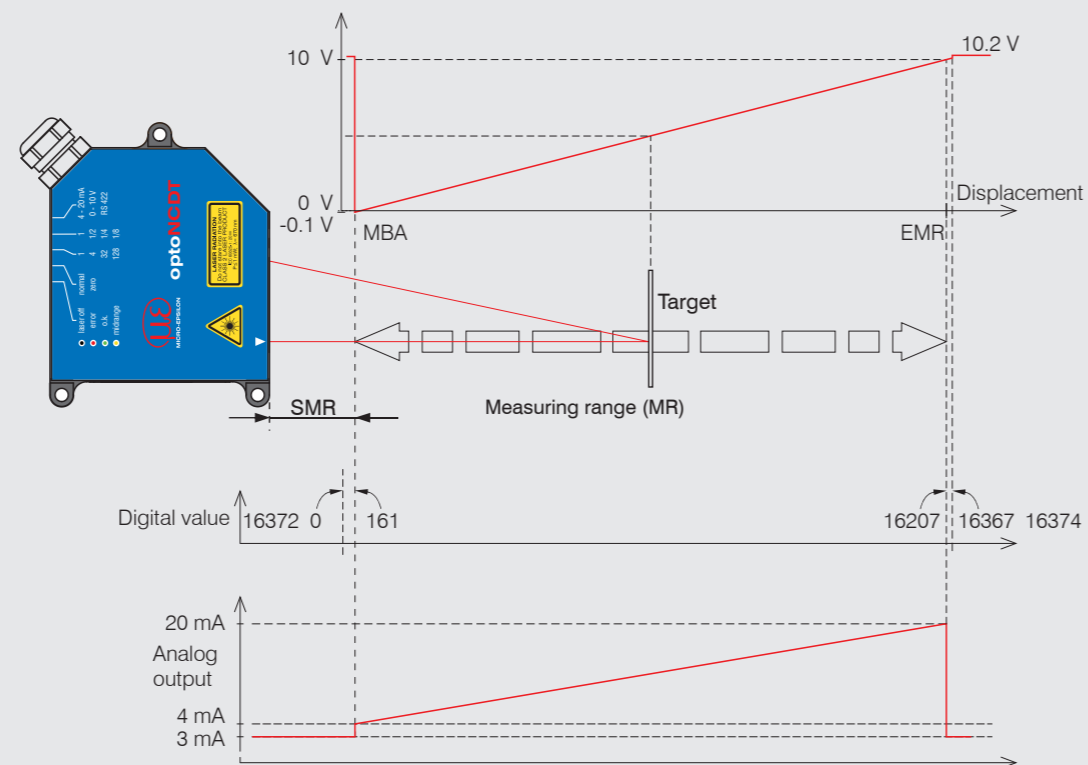

The State LED on sensor indicates the position of target to the sensor.

LED	Color	Meaning	
	○	off	Laser beam is switched off.
State	●	green	Sensor in operation, target in measuring range
	●	yellow	Target is in midrange.
	●	red	Target out of range, too low reflection

Operating Mode

➡ Change the operating mode of the sensor.

Error-Mode (error control, factory setting)

Switching output 1	Switching output 2
Error output	inactive
The switching output 1 is activated (conducting to GND),	
- when the target is outside the measuring range,	
- there is no target present	
- or if the target is unsuitable (too dark, polished metal, insufficiently reflective).	
Function	
- Setting mid-point	
- No limit control	

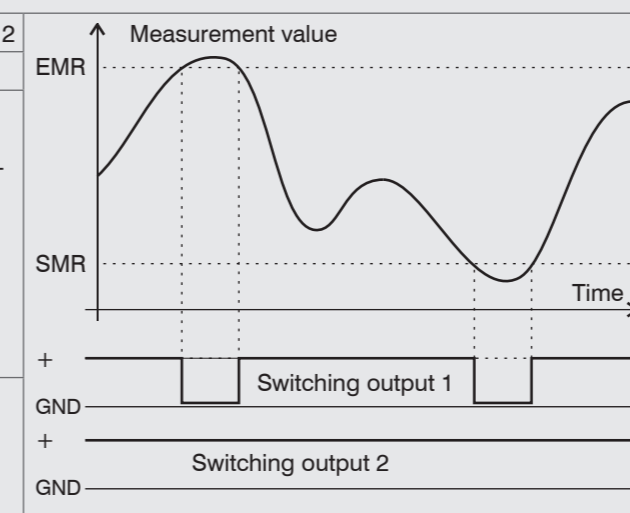

Switch-Mode (limit control)

Switching output 1	Switching output 2
Limit value	Limit value
The switching outputs are activated (conducting to GND),	
- when the target is outside the measuring range,	
- there is no target present	
- or if a target is unsuitable (too dark, polished metal, insufficiently reflective).	
The following 4 values are used:	
- Upper limit (UL), --	
- Lower limit (LL), --	
- Upper hysteresis value (UH), --	
- Lower hysteresis value (LH).	
Function	
- Mastering	
- Limit control	

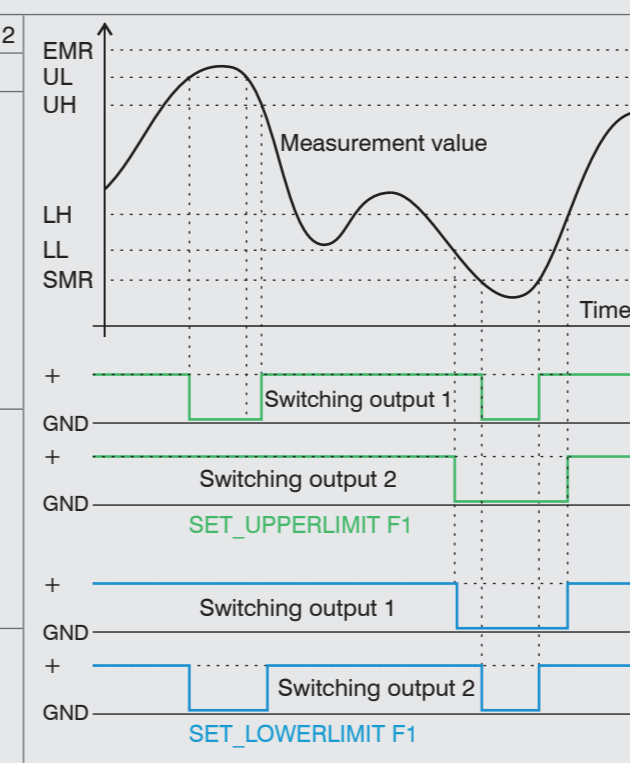

Please refer to the instruction manual for factory settings to the limit and hysteresis values.

Switching Outputs

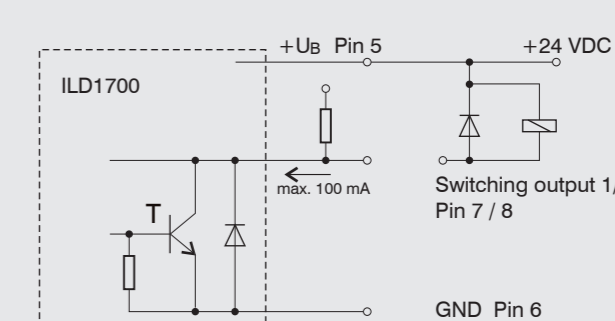

The transistor T is conductive in the active state. The switching outputs are short-circuit-proof.

To reset the short-circuit protection:

- Clear the external short circuit,
- switch off the sensor and switch on again or
- send the software command „Reset“ to the sensor.

The two limit outputs may also be actuated in parallel as window comparator (OK/Not OK separation).

You will find informations on display and signal processing units online at: www.micro-epsilon.com/accessories/index.html.

You can read more information about the sensor in the instruction manual. You will find these online at www.micro-epsilon.de/download/manuals/man--optoNCDT-1700--en.pdf or on the delivered CD.